

TOILETS

SERVICE PARTS BOOK

OCTOBER 2017

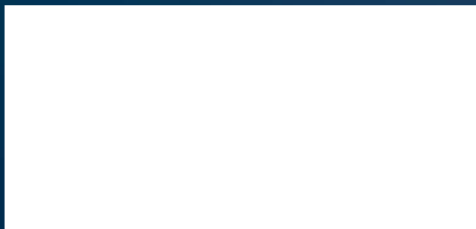

KOHLER[®]
GENUINE PARTS

KOHLER® Toilets Service Parts

Tips for Finding the Right Part

Know if Your Toilet Is a One-Piece or Two-Piece Toilet



One-piece toilets integrate tank and bowl into a seamless design.



Two-piece toilets feature the traditional design of a separate tank and bowl.

Determine Your Toilet’s Flushing Technology

All KOHLER flushing technologies are described, along with their common replacement parts, on pages 4–11. To determine your toilet’s flushing technology, look inside the tank and compare your flushing mechanisms with those pictured in this catalog.

Look for Model and Service Information

Many toilets have service information on the underside of the tank lid.

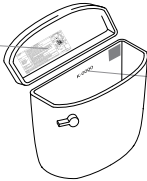

The toilet tank number is imprinted on the inside back of the tank.

For toilet and tank K-number reference, see index on pages 12–13.

Find Your Toilet in the Matrix

If you do not find the part you need pictured on pages 4–11, use the information you have gathered to find your toilet in the corresponding section of the matrix. The replacement part numbers for the float/fill valve, flush valve, tank gasket and flush ball/flapper are listed for each toilet. To view all the service parts for your toilet, visit KOHLER.com/ServiceParts for the expanded service parts pages.

Toilets – Flushing Technologies 4–11

Index by Toilet Model Number 12–13

Toilets – Detailed Parts Matrix

Canister (Single-Fush) One-Piece Toilets	14–17
Canister (Single-Fush) Two-Piece Toilets	18–23
Canister (Dual-Flush) One- and Two-Piece Toilets	24–27
Touchless Toilets	28–29
2-Inch Flapper One-Piece Toilets	30–39
2-Inch Flapper Two-Piece Toilets	40–49
3¼-Inch Flapper One-Piece Toilets	50–51
3¼-Inch Flapper Two-Piece Toilets	52–53
Power Lite® One-Piece Toilets	54–55
Intelligent Toilets	56–57
Pressure Lite® One- and Two-Piece Toilets	58–59
STERLING® Toilets	60–61

Power Lite® One-Piece Toilets

POWER LITE®
KOHLER®

If you have a Power Lite toilet, there will be an electrical cord extending from the toilet to a power outlet.



Power Lite toilets have specific replacement parts for each model.

See pages 54–55 for parts related to Power Lite toilets.

For detailed parts listings, see pages 54–55.

Pressure Lite® One- and Two-Piece Toilets

PRESSURE LITE®
KOHLER®

If you have a Pressure Lite toilet, you will see a holding vessel within the tank.



Pressure Lite toilets have specific replacement parts for each model.

See pages 58–59 for parts related to Pressure Lite toilets.

For detailed parts listings, see pages 58–59.

Canister (Single-Flush) Toilets

CLASS SIX[®]
KOHLER.

CLASS FIVE[®]
KOHLER.

If you have a single-flush canister toilet, you will see a cylinder-shaped flush valve inside the tank instead of a flapper. The seal in the canister works similar to a flapper. **If your toilet is leaking water into the bowl, the seal needs to be replaced, not the canister.**

AquaPiston[®]
The AquaPiston canister allows water to flow into the bowl from all sides (360 degrees), increasing the power and effectiveness of the flush.

Guide Kit
(Includes center guide, cap and chain)
GP1229656



YOUR CAP COLOR DOES NOT MATTER.

Match stem color and insert size.

-If stem is grey with small insert, use GP1138930.



-If stem is black with large insert, use GP1083167.



Must use proper valve for optimal performance.

Proprietary Formulated Yellow Seal
GP1059291



Replaces Red Seal



Two-piece canister toilets will have triangle gasket kit or DryLock[™] gaskets.

GP51487



GP1018165-F
(3" gasket)



1024390
(bolts)



GP1112256
(2" gasket)



1024390
(bolts)



Canister (Dual-Flush) Toilets

DUAL FLUSH
KOHLER.

If you have a dual-flush toilet, you will see a two-button actuator on the top or a two-part trip lever on the side rather than a standard trip lever. You will see a cylinder-shaped flush valve inside the tank instead of a flapper. The seal in the canister works similar to a flapper. **If your toilet is leaking water into the bowl, the seal needs to be replaced, not the canister.**



The innovative two-tone trip lever features two flush options. The longer green lever provides a light 1.1-gallon flush; the full lever provides a full 1.6-gallon flush.



Touchless Flush Toilets



KOHLER® touchless toilets offer a no-touch flush. Just hold your hand over the tank sensor to activate the flush. No handle to touch means fewer germs to pick up or leave behind.

Guide Kit
(Includes center guide,
cap and chain)
GP1229656



Proprietary
Formulated
Yellow Seal
GP1059291



Touchless Unit



YOUR CAP COLOR DOES NOT MATTER.

Match stem color and insert size.

-If stem is grey with small insert,
use GP1138930.



GP1138930
GP1060294M (Mexico)

-If stem is black with large insert,
use GP1083167.



GP1083167
GP1060299M (Mexico)

Must use proper valve for
optimal performance.

Touchless Conversion Kit

K-1954

Upgrade your toilet to a no-touch flush. This easy-to-install retrofit kit brings a KOHLER touchless flush to almost any toilet. Once it's installed, just hold your hand over the tank sensor to activate the flush.



Visit us.KOHLER.com to see if your toilet is compatible.

2-Inch Flapper One-Piece Toilets

Toilets manufactured prior to 2004 most commonly have a 2-inch flapper.



**YOUR CAP COLOR
DOES NOT MATTER.**

Use GP1138930
GP1060294M (Mexico)



For your toilet,
see pages 30–39.

Must use proper valve for
optimal performance.

Flappers

GP84995



Replaces flapper
with rubber bar



GP83064



GP1078440



Replaces discontinued
flappers 88925, 85655,
84138, 84314

GP88921



GP89825 –
For Portrait[®] toilets



2-Inch Flapper Two-Piece Toilets

Toilets manufactured prior to 2004 most commonly have a 2-inch flapper. All two-piece toilets that have a 2-inch flapper use fill valve GP1138930.



YOUR CAP COLOR DOES NOT MATTER.

Use GP1138930
GP106094M (Mexico)



Must use proper valve for optimal performance.

Most two-piece flapper toilets will have:

Tank gasket GP51487



Flappers

GP87449



Replaces these discontinued flappers



GP85160



Replaces these discontinued flappers



GP49114

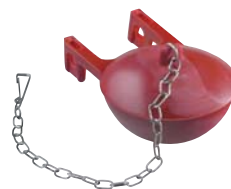

Older toilets may have a black flapper; replace with GP49114.

3¼-Inch Flapper One-Piece Toilets

CLASS FIVE®
KOHLER®

Toilets that have a 3¼-inch flapper are Class Five® toilets.
All Class Five toilets use fill valve GP1083167.



**YOUR CAP COLOR
DOES NOT MATTER.**

Fill valve
GP1083167
GP10060299 (Mexico)



Must use this valve for
optimal performance.

Flappers

GP1039444 – For Cimarron®
and Memoirs®



GP1067183 – For Gabrielle™



GP1060740 – For Portrait®



3¼-Inch Flapper Two-Piece Toilets

CLASS FIVE[®]
KOHLER[®]

Toilets that have a 3¼-inch flapper are Class Five[®] toilets. All Class Five toilets use fill valve GP1083167.



Flapper

GP1078441



**YOUR CAP COLOR
DOES NOT MATTER.**

Fill valve
GP1083167
GP1060299M (Mexico)



Must use this valve for optimal performance.

3" DryLock™ system
gasket GP1018165-F



1024390
(bolts)



INDEX

KOHLER® Toilet Model Numbers

K-10491.....	16	K-14343.....	50	K-3440.....	40	K-3505.....	58
K-10492.....	16	K-14344.....	50	K-3441.....	46	K-3506.....	50
K-10493.....	20	K-14345 (Canister).....	14	K-3444.....	44	K-3509 (Canister).....	20
K-10494.....	22	K-14345 (Flapper).....	50	K-3445.....	42	K-3509 (Flapper).....	52
K-10495.....	18	K-14346 (Canister).....	14	K-3446.....	46	K-3510.....	48
K-11450.....	46	K-14346 (Flapper).....	50	K-3447.....	42	K-3511 (Canister).....	22
K-11451.....	18	K-14509.....	18	K-3448.....	42	K-3511 (Flapper).....	52
K-11452.....	20	K-14797.....	22	K-3449.....	42	K-3512.....	48
K-11453.....	18	K-14799.....	22	K-3450.....	40	K-3513.....	50
K-11456.....	20	K-14824.....	18	K-3451 (2" Flapper).....	32	K-3514.....	48
K-11460 (Canister).....	22	K-15410.....	18	K-3451 (3¼" Flapper).....	50	K-3515 (Canister).....	20
K-11460 (Flapper).....	52	K-3322.....	30	K-3452.....	44	K-3515 (Flapper).....	52
K-11461 (Canister).....	20	K-3323.....	38	K-3453 (2" Flapper).....	32	K-3517.....	18
K-11461 (Flapper).....	52	K-3324.....	30	K-3453 (3¼" Flapper).....	50	K-3519.....	58
K-11465.....	52	K-3357.....	34	K-3454.....	42	K-3520.....	46
K-11470.....	46	K-3360.....	34	K-3455.....	44	K-3521.....	46
K-11471.....	22	K-3378.....	32	K-3456.....	42	K-3524.....	54
K-11473.....	22	K-3379.....	54	K-3457.....	42	K-3526 (Canister).....	22
K-11492.....	22	K-3383.....	32	K-3458.....	58	K-3526 (Flapper).....	52
K-11497.....	22	K-3384.....	38	K-3461.....	44	K-3527.....	46
K-11498.....	22	K-3385.....	36	K-3462.....	44	K-3530.....	40
K-11499.....	22	K-3386.....	34	K-3463.....	42	K-3531.....	58
K-11813.....	18	K-3390.....	30	K-3464.....	44	K-3532 (Canister).....	20
K-11821.....	22	K-3393.....	54, 58	K-3465.....	44	K-3532 (Flapper).....	52
K-11823.....	18	K-3394.....	58	K-3466.....	38	K-3533 (Canister).....	22
K-11844.....	20	K-3395.....	38	K-3467.....	38	K-3533 (Flapper).....	52
K-11889.....	50	K-3397.....	38	K-3468.....	44	K-3535.....	40
K-11899.....	38	K-3398.....	54	K-3470.....	40	K-3536.....	40
K-11968.....	22	K-3400.....	32	K-3471.....	40	K-3542 (Canister).....	20
K-12697.....	18	K-3401.....	30	K-3472.....	40	K-3542 (Flapper).....	52
K-12698.....	18	K-3402.....	34	K-3475.....	40	K-3544.....	58
K-12767.....	20	K-3404.....	58	K-3477.....	40	K-3546.....	58
K-14076.....	46	K-3405.....	32	K-3478.....	40	K-3548 (Canister).....	22
K-14110.....	40	K-3406.....	36	K-3479.....	40	K-3548 (Flapper).....	52
K-14128.....	40	K-3407.....	46	K-3480.....	40	K-3551.....	18
K-14133.....	46	K-3408.....	30	K-3481.....	46	K-3554.....	58
K-14143.....	46	K-3410.....	44	K-3482.....	44	K-3555.....	44
K-14150.....	40	K-3411.....	44	K-3483.....	44	K-3556.....	40
K-14178.....	44	K-3412.....	44	K-3484.....	42	K-3557.....	40
K-14210.....	46	K-3414.....	46	K-3485.....	44	K-3564.....	26
K-14213.....	40	K-3415.....	46	K-3486.....	44	K-3574.....	22
K-14230.....	34	K-3417.....	42	K-3487.....	52	K-3575.....	22
K-14239.....	44	K-3419.....	42	K-3488.....	30	K-3576.....	22
K-14247.....	44	K-3420.....	42	K-3489.....	50	K-3577.....	22
K-14250.....	40	K-3421.....	46	K-3490.....	44	K-3588.....	24
K-14257.....	30	K-3422.....	46	K-3491.....	44	K-3589.....	18
K-14258.....	30	K-3423.....	46	K-3492.....	54	K-3591.....	44
K-14261.....	34	K-3427.....	46	K-3493.....	58	K-3597.....	58
K-14268.....	30	K-3428.....	46	K-3496 (Canister).....	18	K-3598.....	26
K-14286.....	30	K-3429.....	44	K-3496 (Flapper).....	52	K-3600.....	32
K-14289.....	36	K-3432.....	46	K-3497 (Canister).....	18	K-3607.....	54, 58
K-14290.....	36	K-3433.....	46	K-3497 (Flapper).....	52	K-3608.....	50
K-14291.....	36	K-3434.....	34	K-3499.....	52	K-3609.....	18
K-14338.....	26	K-3435.....	36	K-3500.....	48	K-3611.....	22
		K-3437.....	54	K-3502.....	48	K-3612.....	34
		K-3438.....	46	K-3503.....	52	K-3615.....	14
		K-3439.....	44	K-3504.....	48	K-3619.....	14

K-3639.....	14
K-3651.....	44
K-3652.....	58
K-3654.....	24
K-3655.....	30
K-3667.....	22
K-3668.....	22
K-3669.....	22
K-3670.....	30
K-3678.....	18
K-3713.....	22
K-3722.....	16
K-3723.....	26
K-3753.....	24
K-3754.....	20
K-3755.....	20
K-3797.....	26
K-3802.....	50
K-3803.....	38
K-3804.....	34
K-3810.....	16
K-3811.....	16
K-3812.....	14
K-3813.....	14
K-3816.....	20
K-3817.....	22
K-3818.....	20
K-3819.....	22
K-3825.....	14
K-3827.....	18
K-3828.....	14
K-3837.....	18
K-3851.....	18
K-3887.....	18
K-3888.....	18
K-3889.....	22
K-3933.....	22
K-3900.....	56
K-3901.....	56
K-3940.....	14
K-3946.....	14
K-3947.....	22
K-3948.....	22
K-3949.....	22
K-3950.....	22
K-3977.....	22
K-3978.....	22
K-3979.....	22
K-3981.....	16
K-3986.....	20
K-3987.....	26
K-3988.....	26
K-3989.....	26
K-3997.....	22
K-3998.....	22
K-3999.....	22
K-4000.....	28
K-4007.....	16

K-45979.....	24
K-45989.....	24
K-5172.....	16
K-5692.....	28
K-5693.....	28
K-6303.....	26
K-6418.....	28
K-6419.....	28
K-6424.....	16
K-6428.....	16
K-6669.....	22
K-6925.....	14
K-6999.....	22
K-98864.....	26
K-98976.....	18
K-98977.....	18
K-98992.....	18
K-98993.....	16
K-98994.....	22

KOHLER® Tank Model Numbers

K-14078.....	46
K-14108.....	40
K-14129.....	40
K-14137.....	46
K-14147.....	46
K-14154.....	40
K-14179.....	44
K-14212.....	46
K-14215.....	40
K-14241.....	44
K-14249.....	44
K-14252.....	40
K-3613.....	44
K-4136.....	24
K-4137.....	24
K-4166.....	18
K-4167.....	18
K-4209.....	46
K-4383.....	18
K-4401.....	42
K-4403.....	42
K-4418.....	18
K-4419.....	24
K-4421.....	18
K-4431.....	18
K-4433.....	20
K-4434.....	22
K-4436.....	22
K-4437.....	22
K-4438.....	18
K-4441.....	26
K-4442.....	24
K-4445.....	42
K-4446.....	18
K-4447.....	42
K-4454.....	44

K-4456.....	40
K-4458.....	26
K-4464.....	44
K-4467.....	22
K-4468.....	22
K-4469.....	20
K-4470.....	58
K-4472.....	24
K-4473 (Canister).....	22
K-4473 (Flapper).....	52
K-4474.....	20
K-4484.....	58
K-4485 (Canister).....	20
K-4485 (Flapper).....	52
K-4491 (Tank).....	20
K-4491 (Flapper).....	52
K-4492 (Tank).....	22
K-4492 (Flapper).....	52
K-4493.....	18
K-4501.....	40
K-4504.....	46
K-4505.....	40
K-4509.....	40, 48
K-4512.....	46
K-4515.....	44
K-4516.....	44
K-4518.....	46
K-4519.....	46
K-4524.....	48
K-4586.....	42
K-4590.....	44
K-4591.....	40
K-4597.....	46
K-4605.....	40
K-4606.....	42
K-4608.....	44
K-4609.....	44
K-4619.....	42
K-4620.....	46
K-4621.....	46
K-4628.....	44
K-4632.....	22
K-4633.....	52
K-4634 (Canister).....	18
K-4634 (Flapper).....	52
K-4641.....	20
K-4642.....	22
K-4645.....	58
K-4646.....	46
K-4708.....	52
K-4742.....	26
K-4807.....	44
K-4835.....	18
K-4841.....	22
K-4899.....	22
K-5380.....	20
K-6284.....	26

STERLING® Toilet & Tank Model Numbers

402014.....	60
402015.....	60
402020.....	60
402024.....	60
402025.....	60
402027.....	60
402028.....	60
402075.....	60
402076.....	60
402077.....	60
402078.....	60
402079.....	60
402080.....	60
402081.....	60
402082.....	60
402083.....	60
402084.....	60
402085.....	60
402087.....	60
402088.....	60
402093.....	60
402212.....	60
402213.....	60
402214.....	60
402215.....	60
402220.....	60
402315.....	60
402375.....	60
402502.....	60
402522.....	60
402532.....	60
403080.....	60
403081.....	60
403082.....	60
404700.....	60
404701.....	60
404702.....	60
404705.....	60
402022.....	60
402023.....	60
402071.....	60
402091.....	60
404514.....	60
404515.....	60
404520.....	60
404544.....	60
404551.....	60
404552.....	60
404555.....	60

Canister (Single-Flush) One-Piece Toilets

Toilet













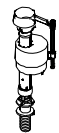

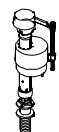
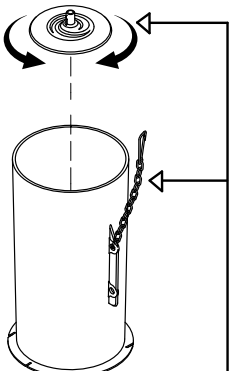
Toilet Details

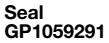
Canister (Single-Flush) Toilets

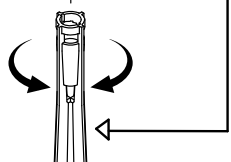
Product Name	Model Number	Tank Cover	Trip Lever
Adair® 	K-3946 K-6925	1180586* 	1034693* LH 1036058* RH 
Archer® 	K-3639	1046467* 	1067577* 
Cimarron® 	K-3828	1036367* 	1034693* LH 1036058* RH 
Cimarron With Concealed Trapway 	K-3619	1036367* 	1034693* LH 1036058* RH 
Gabrielle™ 	K-3615 K-3825 Artist Editions®: K-14345, K-14346	85407* 	1025329* LH 1025330* RH 1068627* LH 1080378* RH 
Kathryn® 	K-3940	1006066* 	1211496* LH 1264712* RH 
Memoirs® Classic   Memoirs Stately	K-3812 (Classic) K-3813 (Stately)	1220279* Classic  1220280* Stately 	1160316* LH  1160317* RH 

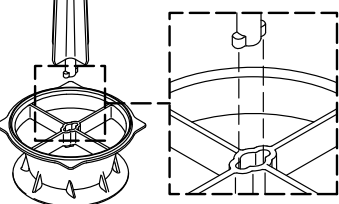
Canister (Single-Flush) One-Piece Toilets
KOHLER® Genuine Parts

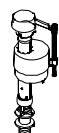
Canister
 (Single-Flush) Toilets

Float/Fill Valve	Chain/Guide/Seal	Canister	Tank Gasket
GP1083167 		1218038	GP83996 
GP1083167 	<p>NOTE: The canister should not fail. If leaking occurs, replace seal GP1059291.</p>	1216616	GP83996 
GP1060299M (Mexico Only)			
GP1083167 		1216624	GP83996 
GP1060299M (Mexico Only)			
GP1083167 		1255785	GP83996 
GP1083167 		1216611	GP83996 
GP1083167 		1211498	GP83996 
GP1083167 	<p>If tabs on guide or cap break, replace with GP1229656</p>	1216612	GP83996 
GP1083167 			







Note: Part numbers that have a "GP" prefix refer to a blister package. For example, GP1059291 is the same part as previous part number 1059291 but in a blister package.

Canister (Single-Flush) One-Piece Toilets

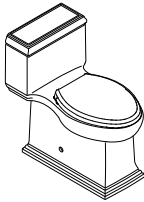
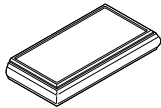
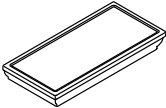
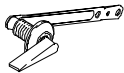
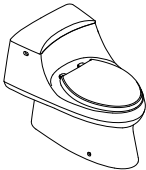
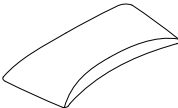
Toilet

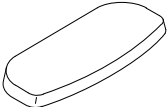

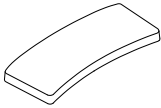

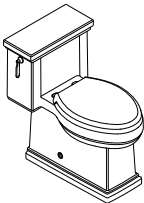
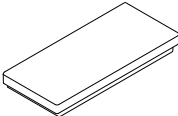
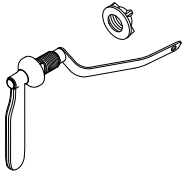



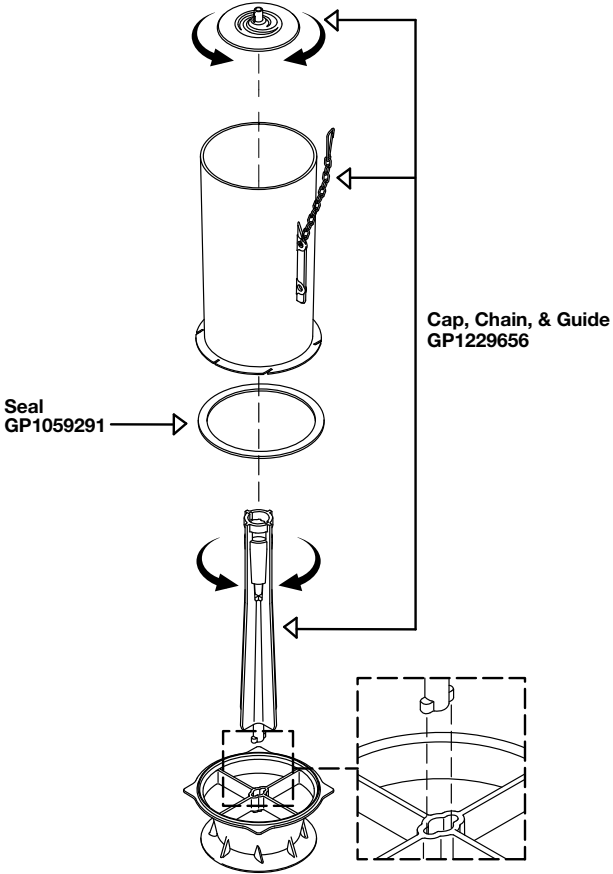

Toilet Details

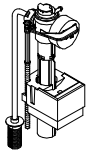
Canister
(Single-Flush) Toilets

Product Name	Model Number	Tank Cover	Trip Lever
Memoirs [®] Skirted 	K-6424 (Classic) K-6428 (Stately)	1220279* Classic  1220280* Stately 	1160316* 
San Raphael [®] 	K-3722	1126374* 	1128497* 
Santa Rosa [™] 	1.28 GPF 1.6 GPF K-3810 K-3811 K-10491 K-10492 K-98993	88497* 	1158701* LH 1245886* RH 
San Souci [®] 	K-5172 (Elongated) K-4007 (Round-Front)	1182368* (Elongated)  1242241* (Round-Front)	1238613* LH (Elongated) 1241200* RH (Elongated)  1241416* LH (Round-Front)
Tresham [®] 	K-3981	1223375* 	1161319* 

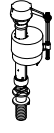
Canister (Single-Flush) One-Piece Toilets
KOHLER® Genuine Parts

Canister
(Single-Flush) Toilets











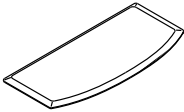

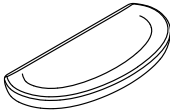

Float/Fill Valve	Chain/Guide/Seal	Canister	Tank Gasket
<p>GP1138930</p> 	<p>NOTE: The canister should not fail. If leaking occurs, replace seal GP1059291.</p>  <p align="center">Cap, Chain, & Guide GP1229656</p> <p>Seal GP1059291</p> <p align="center">If tabs on guide or cap break, replace with Kit GP1229656</p>	<p>1244399</p>	<p>GP83996</p> 
<p>1128657</p> 		<p>1238986 Flapper 1138648</p> 	<p>GP83996</p> 
<p>GP1083167</p>  <p>GP1060299M (Mexico Only)</p>		<p>1.6 GPF 1216619</p> <p>1.28 GPF 1216612 1216625 (Mexico)</p>	<p>GP83996</p> 
<p>1237539 (Elongated)</p> 		<p>1237538 (Elongated) 1227235 (Round-Front)</p>	<p>GP83996</p> 
<p>1241415 (Round)</p> 		<p>1244399</p>	<p>GP83996</p> 

Note: Part numbers that have a "GP" prefix refer to a blister package. For example, GP1059291 is the same part as previous part number 1059291 but in a blister package.

Canister (Single-Flush) Two-Piece Toilets

Toilet Details

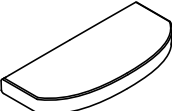

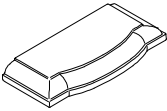
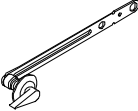







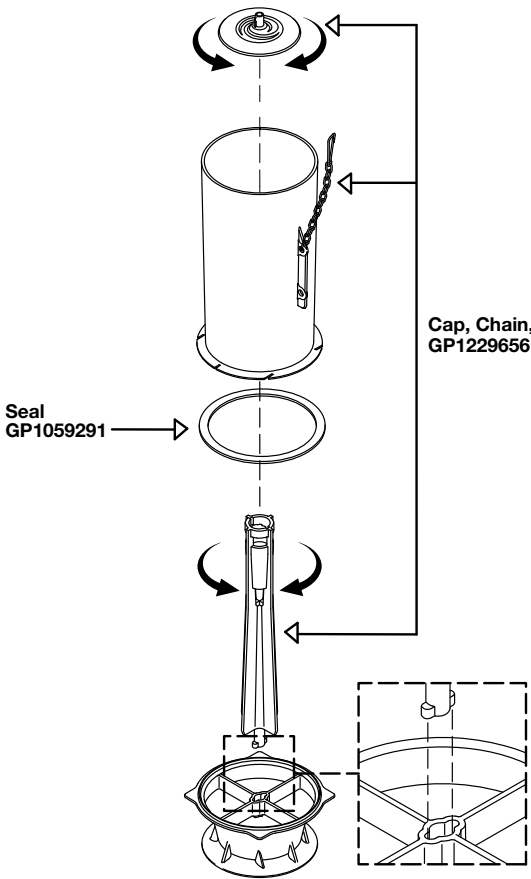

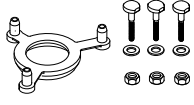

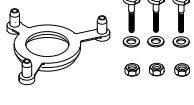

Canister
(Single-Flush) Toilets

Product Name	Model Number	Tank Cover	Trip Lever
Archer® 	1.28 GPF K-3551, K-10495 Tank: K-4431 1.6 GPF K-3517 Tank: K-4493	1046467* 	1067577* 
Bancroft® 	K-3827 Tank: K-4383	1033723* 	1042212* 
Cavata® 	K-12697 K-12698 Tank: K-4835	1145294* 	1154764* 
Cimarron® 	Elongated 1.28 GPF K-3609, K-11451, K-11813, K-98977 Tank: K-4421 1.6 GPF K-3589, K-11456, K-11823 Tank: K-4418	1086929* 	1034693* LH 1116014* RH 
	Round-Front 1.28 GPF K-3851, K-3887, K-14509, K-15410, K-98976 Tank: K-4166 1.6 GPF K-3888 Tank: K-4167		
	Elongated 1.28 GPF K-3496-HE, K-3496, K-3497, K-3499 Tank: K-4634-HE, K-4634		
Cimarron With Skirted Trapway 	K-5310 Tank: K-4369	1086929* 	1034693* LH 1116014* RH 
Devonshire® 	1.28 GPF K-3837, K-14824, K-98992 Tank: K-4438	1044820* 	1160316* LH 1160317* RH 
	1.28 GPF K-3678 Tank: K-4446		

Canister (Single-Flush) Two-Piece Toilets

KOHLER® Genuine Parts

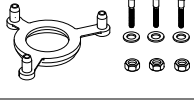
Canister
(Single-Flush) Toilets











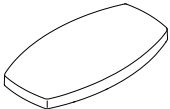
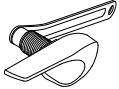
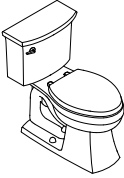
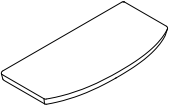

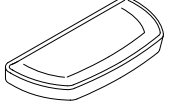
Float/Fill Valve	Chain/Guide/Seal	Canister	Tank Gasket	
GP1083167  GP1060299M (Mexico Only)	<p style="text-align: center;">NOTE: The canister should not fail. If leaking occurs, replace seal GP1059291.</p>  <p style="text-align: center;">Cap, Chain, & Guide GP1229656</p> <p style="text-align: center;">Seal GP1059291</p> <p style="text-align: center;">If tabs on guide or cap break, replace with GP1229656</p>	1.28 GPF 1216613 1216621 (Mexico)	GP1018165-A (1.6 GPF) GP1018165-F (1.28 GPF)  1024390	
GP1083167  GP1060299M (Mexico Only)		1216614	GP51487 	
GP1083167  GP1060299M (Mexico Only)		1161447	GP51487 	
GP1083167  GP1060299M (Mexico Only)		1188999 1190386 (Lined Tank)	1.28 GPF 1188999 1190386 (Lined Tank)	GP1112256 
GP1083167  GP1060299M (Mexico Only)		1189000 1191371 (Lined Tank)	1.28 GPF 1189000 1191371 (Lined Tank)	1024390 
GP1138930 		1059288 (HE) 1083980	1.28 GPF 1059288 (HE) 1083980	GP1112256 
GP1138930 		1188998	1188998	1024390 
GP1083167  GP1060299M (Mexico Only)		1216615	1216615	GP51487 
GP1083167  GP1060299M (Mexico Only)		1126916	1126916	GP1018165-F  1024390

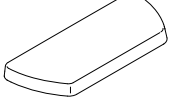
Note: Part numbers that have a "GP" prefix refer to a blister package. For example, GP1059291 is the same part as previous part number 1059291 but in a blister package.

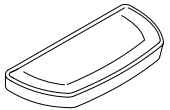
Canister (Single-Flush) Two-Piece Toilets
Toilet

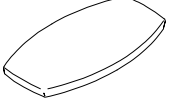

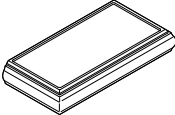













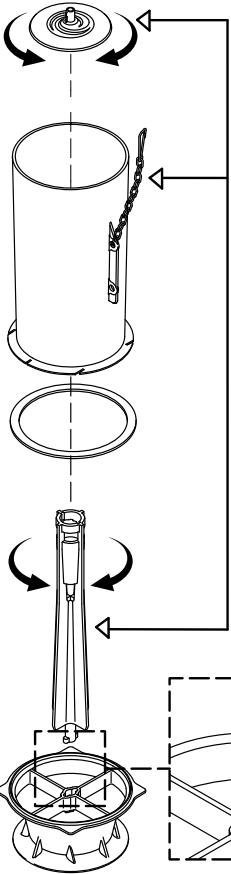

Toilet Details

Canister
(Single-Flush) Toilets

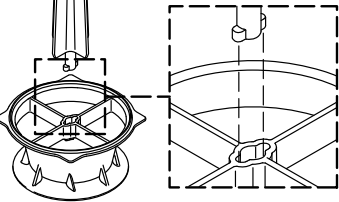
Product Name	Model Number	Tank Cover	Trip Lever	
Elliston® 	K-12767 Tank: K-5380	1211811* 	1213839* 	
Elmbrook™ 	K-45983 Complete Solution	1282458* 	1288036* 	
Highline® 	K-5298 Tank: K-5308	1138565* 	1142713* 	
Highline Classic 	K-5299 Tank: K-5307	84591* 	1117207* LH 1133133* RH 	
Highline With Concealed Trapway 	K-76301 Tank: K-5311	1138565* 	1142713* 	
Kelston® 	1.28 GPF K-11453, K-11844, K-3755 Tank: K-4469	1.6 GPF K-3754, K-11452 Tank: K-4474	1070414* 	1075394* 
Memoirs® Classic 	1.28 GPF K-3986, K-3816, K-10493 Tank: K-4433	1052861* Classic 	1160316* LH 1160317* RH 	
	1.6 GPF K-3818 Tank: K-4641			
	K-11461, K-3509, K-3515 Tank: K-4491			
	K-3532, K-3542 Tank: K-4485 (Lined)			

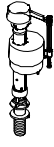
Canister (Single-Flush) Two-Piece Toilets
KOHLER® Genuine Parts

Canister
(Single-Flush) Toilets

Float/Fill Valve	Chain/Guide/Seal	Canister	Tank Gasket
GP1083167 		1216610	GP1018165-F  1024390 
GP1083167 	<p>NOTE: The canister should not fail. If leaking occurs, replace seal GP1059291.</p>	1288037	GP1018165  1024390 
GP1083167 		1294218	GP51487 
GP1083167 	 <p align="center">Cap, Chain, & Guide GP1229656</p>	1.0 GPF 1294217	GP51487 
GP1138930 	<p>Seal GP1059291 →</p>	1294219	GP51487 
GP1083167  GP1060299M (Mexico Only)		1.28 GPF 1216610 1.6 GPF 1216609	GP1018165-F 
GP1083167 	<p>* If tabs on guide or cap break, replace with GP1229656</p>	1.28 GPF 1116617 1216622 (Lined Tank) 1.6 GPF 1152861 (Lined Tank) 1216620 (K-4641) 1080961 (K-4491)	1.28 GPF GP51487  <hr/> 1.6 GPF GP1018165-F  1024390 











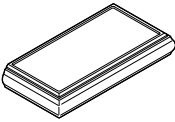

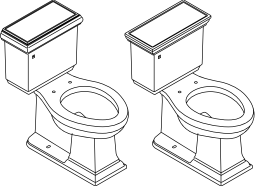
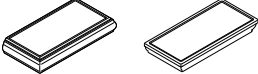
Note: Part numbers that have a "GP" prefix refer to a blister package. For example, GP1059291 is the same part as previous part number 1059291 but in a blister package.

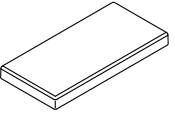
Canister (Single-Flush) Two-Piece Toilets

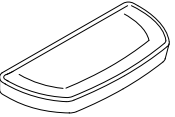
Toilet

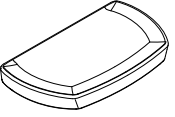

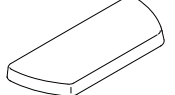
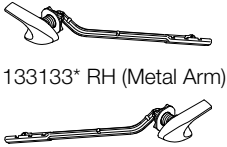

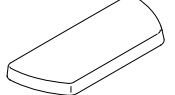
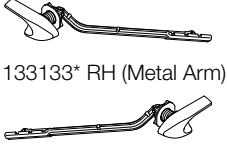





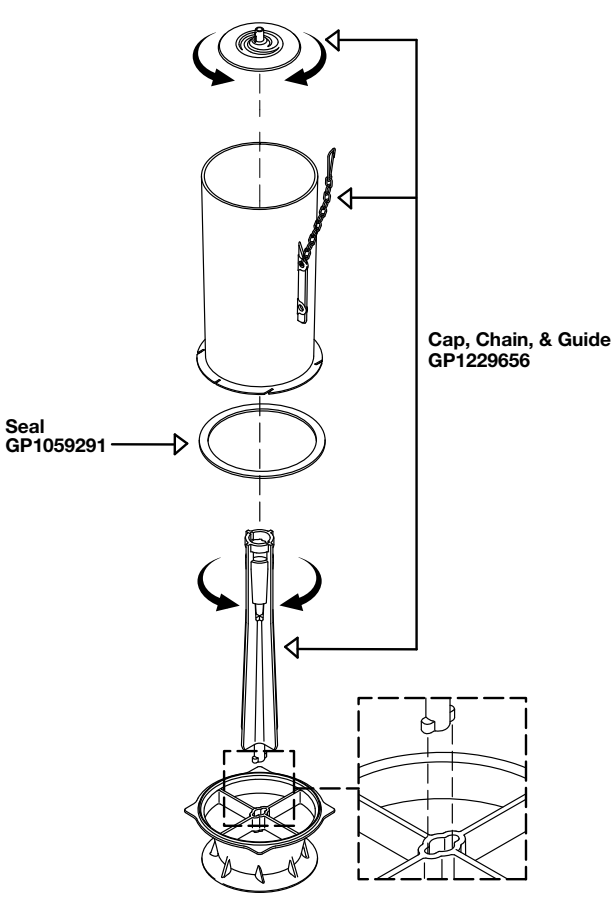

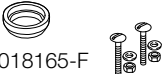

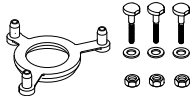
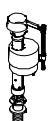
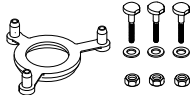
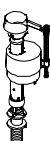

Toilet Details

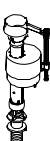
Canister (Single-Flush) Toilets

Product Name	Model Number	Tank Cover	Trip Lever
Memoirs® Stately 	1.28 GPF K-3933, K-3817, K-10494, K-98994 Tank: K-4434 1.6 GPF K-3819 Tank: K-4642 K-3511, K-3526, K-11460 Tank: K-4492 K-3533, K-3548, K-11968 Tank: K-4473 (Lined Tank)	1052862* Stately 	1160316* LH 1160317* RH 
Memoirs With Concealed Trapway 	Classic K-6999 Tank: K-4433 Stately K-6669 Tank: K-4434	1052861* Classic 1052862* Stately 	1160316* LH 1160317* RH 
Tresham® 	K-3950 Tank: K-4899	1146775* 	1161319* 
Wellworth®, Highline® 	1.28 GPF K-3997, K-3998, K-3999, K-3889, K-5481 Tank: K-4467 1.6 GPF K-3977, K-3978, K-3979 Tank: K-4468	1138565* 	1142713* 
Wellworth, Highline 	K-3947, K-3948, K-3949 Tank: K-4841	1145223* 	1142713* 
Wellworth Classic, Highline Classic 	1.28 GPF K-3658, K-3713 Tank: K-4436 1.6 GPF K-11821, K-11471, K-11473, K-11492, K-3574, K-3576, K-3611 Tank: K-4632	84591* 84095* (14" Tank) 	1117207* LH (Metal Arm) 1069723* LH (Plastic Arm) 1133133* RH (Metal Arm) 
Wellworth Classic 	1.28 GPF K-3575, K-3577, K-11497, K-11498, K-11499, K-14797, K-14799, K-11464, K-76407, K-5296, K-17068 Tank: K-4436 1.6 GPF K-3667, K-3668, K-3669 Tank: K-4437	84591* 84095* (14" Tank) 	1117207* LH (Metal Arm) 1133133* RH (Metal Arm) 

Canister (Single-Flush) Two-Piece Toilets KOHLER® Genuine Parts

Canister
(Single-Flush) Toilets

Float/Fill Valve	Chain/Guide/Seal	Canister	Tank Gasket	
<p>GP1083167</p> 	<p style="text-align: center;">NOTE: The canister should not fail. If leaking occurs, replace seal GP1059291.</p>  <p style="text-align: center;">Cap, Chain, & Guide GP1229656</p> <p style="text-align: center;">Seal GP1059291</p> <p style="text-align: center;">If tabs on guide or cap break, replace with GP1229656</p>	<p>1.28 GPF 1116617 1216622 (Lined Tank)</p> <p>1.6 GPF 1152861 (Lined Tank) 1216620 (K-4642) 1080961 (K-4492)</p>	<p>1.28 GPF GP51487</p>  <hr/> <p>1.6 GPF GP1018165-F 1024390</p> 	
<p>GP1083167</p> 		1216617	GP51487	
<p>GP1083167</p>  <p>GP1060299M (Mexico Only)</p>		1216618	GP51487	
<p>GP1083167</p>  <p>GP1060299M (Mexico Only)</p>		1.28 GPF 1142714 115553 (Lined Tank)	GP51487	
<p>GP1083167</p> 		1151862 1160809 (Lined Tank)	GP51487	
<p>GP1083167</p> 		1.28 GPF 1117210	GP51487	
<p>GP1083167</p> 		1.6 GPF 1069722 (Plastic Arm)	GP1018165-F 1024390	
<p>GP1083167</p> 	1.28 gpf 1117210 1130564 (Lined Tank)	GP51487		
<p>GP1083167</p> 	1.6 gpf 1158795 1158796 (Lined Tank)	GP51487		

Note: Part numbers that have a "GP" prefix refer to a blister package.
For example, GP1059291 is the same part as previous part number 1059291 but in a blister package.







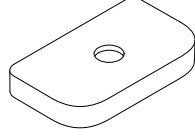



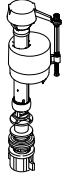
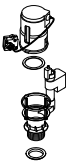

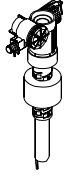
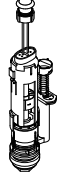

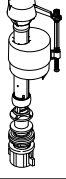

Canister (Dual-Flush) One- and Two-Piece Toilets

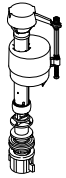
Toilet Details

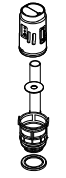
Canister
(Dual-Flush) Toilets

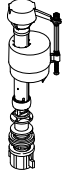
Product Name	Model Number	Tank Cover	Trip Lever/Flush Actuator
Cavata® 	K-45989 Tank: K-4137	1145294* 	1203699* 
Escala® 	K-3588 Tank: K-4472	1045184* 	1266856* 
Highline® 	K-45979 Tank: K-4136	84591* 	1208884* 
Persuade® 	K-3654 Tank: K-4419	Discontinued Service With 1260938* & 1265519*  Hole: 1 1/16" (40 mm)	1266856*  For use with 1 1/16" hole
		1260938*  Hole: 2" (51 mm)	1265519*  For use with 2" hole
Persuade Circ 	K-3753 Tank: K-4442	Discontinued Service With 1238836* & 1265519*  Hole: 1 1/16" (40 mm)	1266856*  For use with 1 1/16" hole
		1238836*  Hole: 2" (51 mm)	1265519*  For use with 2" hole

Canister (Dual-Flush) One- and Two-Piece Toilets
 KOHLER® Genuine Parts

Float/Fill Valve	Flush Valve	Tank Gasket	Canister Seal
GP1083167 	1203698 	GP51487 	1203764 
1246185 	1095687* 	1036170 	1131496 
GP1083167 	1208883 	GP51487 	1203764 
GP1138930 	Service with 1266856* flush actuator and 1269696 flush valve	1107584 	1131496 
	1269696 		1270755 
GP1138930 	Service with 1266856* flush actuator and 1269696 flush valve	1107584 	1131496 
	1269696 		1270755 









Canister
 (Dual-Flush) Toilets

Note: Part numbers that have a "GP" prefix refer to a blister package.
 For example, GP1059291 is the same part as previous part number 1059291 but in a blister package.

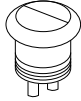
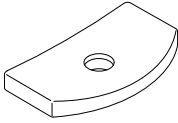

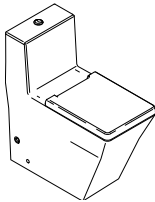
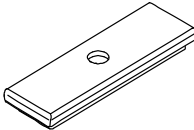

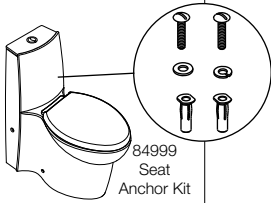
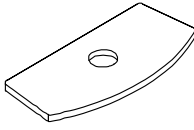
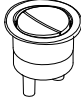
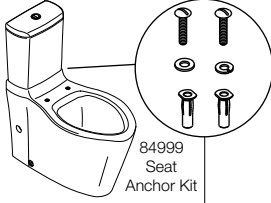

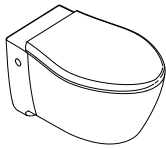
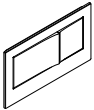
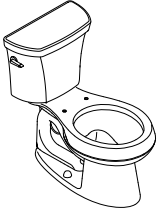
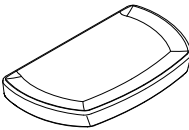
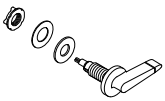

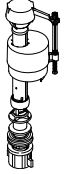

Canister (Dual-Flush) One- and Two-Piece Toilets
Toilet

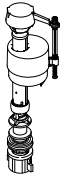
Toilet Details

Canister
(Dual-Flush) Toilets

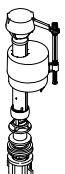
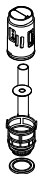
Product Name	Model Number	Tank Cover	Trip Lever/Flush Actuator
Persuade [®] Curv 	K-3723, K-98864 Tank: K-4441	Discontinued Service With 1217371* & 1265519*  Hole: 1 1/8" (40 mm)	1266856*  For use with 1 1/8" hole
		1217371*  Hole: 2" (51 mm)	1265519*  For use with 2" hole
Réve [®] 	K-3797	1113930* 	1266856* 
Saile [®] 	K-3564 Artist Editions [®] : K-14338	1081363* 	1266856* 
Strela [®] 	K-3598 Tank: K-4742	Discontinued	1266856* 
Veil [®] 	K-6300, 6303, 6304 In-Wall Tank: K-6284, K-18829	N/A	K-6298* 
Wellworth [®] 	K-3987, K-3988, K-3989 Tank: K-4458	1138565* 	1208884* LH 1203699* RH 

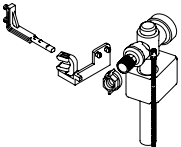
Canister (Dual-Flush) One- and Two-Piece Toilets
 KOHLER® Genuine Parts

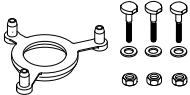
Float/Fill Valve	Flush Valve	Tank Gasket	Canister Seal
GP1138930 	Service with 1266856* flush actuator and 1269696 flush valve <hr/> 1269696 	1107584 	1131496  <hr/> 1270755 
GP1138930 	1119360 	1118481 	1131496 
GP1138930 	1097231 	GP83996 	1131496 
GP1138930 	Use 1269696* & 1266856* 	1107584 	1131496 
1155514 	1155519 	1150348 	N/A
GP1083167 	1208885 LH 1224140 RH 	GP51487 	1203764 

Canister
 (Dual-Flush) Toilets







Note: Part numbers that have a "GP" prefix refer to a blister package.
 For example, GP1059291 is the same part as previous part number 1059291 but in a blister package.

Touchless Toilets



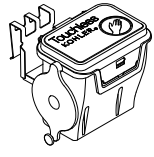

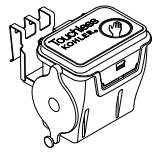

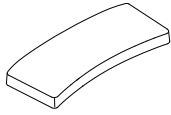
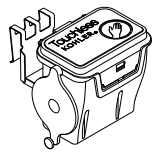
Toilet

Toilet Details

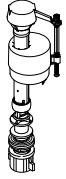
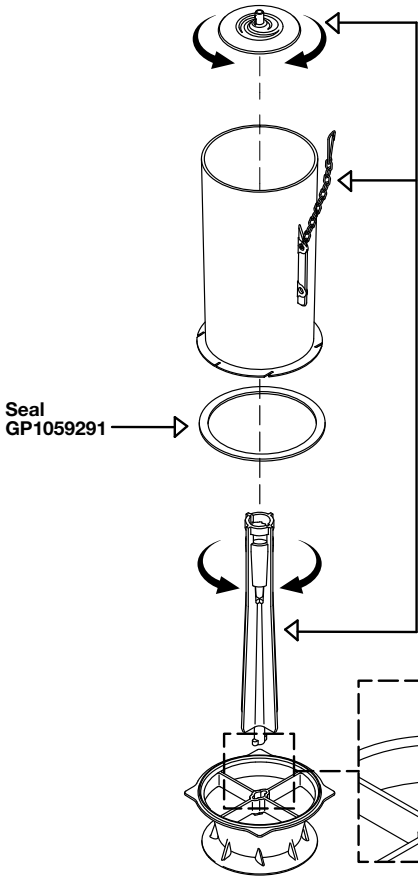
Touchless Toilets

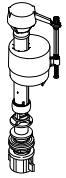
Product Name	Model Number	Tank Cover	Touchless
<p>Cimarron® Elongated</p> 	<p>K-6418 Tank: K-5692</p>	<p>1086929*</p> 	<p>1256315</p> 
<p>Cimarron Round-Front</p> 	<p>K-6419 Tank: K-5693</p>	<p>1086929*</p> 	<p>1256315</p> 
<p>San Souci®</p> 	<p>K-4000</p>	<p>1182368*</p> 	<p>1256315</p> 

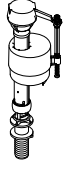
Touchless Toilets KOHLER® Genuine Parts

Float/Fill Valve	Chain/Guide/Seal	Canister	Tank Gasket
<p>GP1083167</p> 	<p>NOTE: The canister should not fail. If leaking occurs, replace seal GP1059291.</p>  <p style="text-align: center;">Cap, Chain, & Guide GP1229656</p> <p>Seal GP1059291</p> <p style="text-align: center;">If tabs on guide or cap break, replace with GP1229656</p>	<p>1241992</p>	<p>GP1112256</p> 
<p>GP1138930</p> 		<p>1241991</p>	<p>GP1112256</p> 
<p>1237539</p> 		<p>1227235</p>	<p>GP83996</p> 







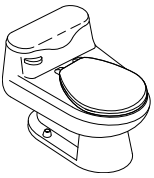
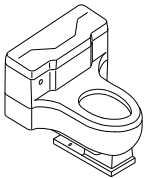
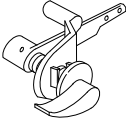
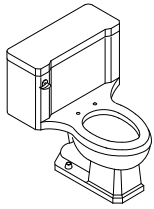

Touchless Toilets

Note: Part numbers that have a "GP" prefix refer to a blister package. For example, GP1059291 is the same part as previous part number 1059291 but in a blister package.

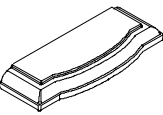
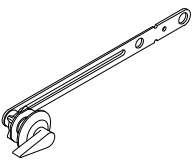
2-Inch Flapper One-Piece Toilets

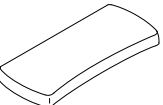

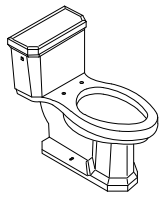
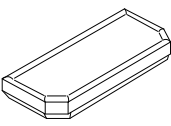





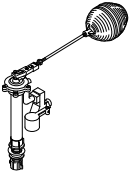
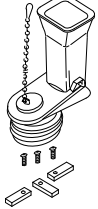
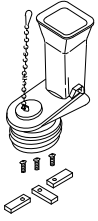
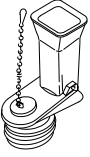

Toilet

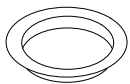
Toilet Details

Product Name	Model Number	Tank Cover	Trip Lever
Cabernet™ 	K-3401 K-3408	Discontinued	Various trip levers; visit KOHLER.com/ServiceParts .
Champlain™ 	K-3390	Discontinued	77046* 
Channel™, Bolton™ 	K-3655 K-3670	Discontinued	500195* 
Devonshire® 	K-3488	1021921* 	1031599* 
Gabrielle™ 	K-3322 Artist Editions®: K-14257, K-14258, K-14286	85407* 	1025329* LH  1025330* RH 
Kathryn® 	K-3324 Artist Editions: K-14268	1006066* 	K-9451*  85085* 

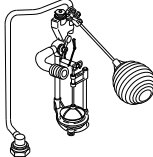
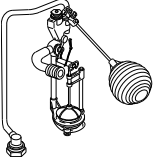
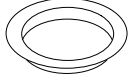
**2-Inch Flapper
One-Piece Toilets**

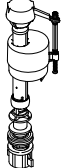
2-Inch Flapper One-Piece Toilets KOHLER® Genuine Parts

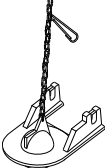
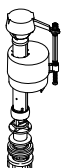
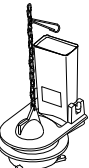
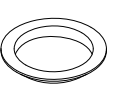
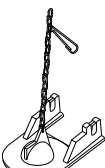
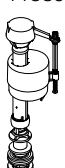
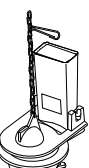
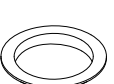
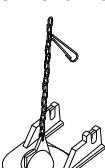
Float/Fill Valve	Flush Valve	Tank Gasket	Flush Ball/Flapper
<p>84499</p>  	<p>83650</p>  <hr/> <p>83094</p>  <p>DISCONTINUED Use 83094</p>   <p>If your toilet currently has this style flush valve and flapper, we recommend they be replaced with flush valve 83094 to prevent potential water damage.</p>	<p>GP53410</p>  <p>GP83888</p> 	<p>GP83064</p>  <p>GP83064</p> 
<p>30669</p> 	<p>30669</p> 	<p>GP53410</p> 	<p>GP88921</p> 
<p>Discontinued</p>	<p>Discontinued</p>	<p>N/A</p>	
<p>GP1138930</p> 	<p>1032640</p> 	<p>GP83996</p> 	<p>GP1078440</p> 
<p>GP1138930</p> 	<p>87998</p> 	<p>GP83996</p> 	<p>GP1078440</p> 
<p>GP1138930</p> 	<p>87998</p> 	<p>GP83996</p> 	<p>GP1078440</p> 







2-Inch Flapper
One-Piece Toilets

Note: Part numbers that have a "GP" prefix refer to a blister package.
For example, GP1059291 is the same part as previous part number 1059291 but in a blister package.

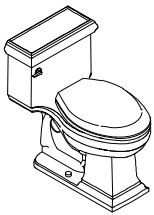
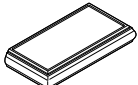
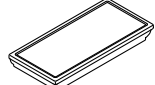
2-Inch Flapper One-Piece Toilets

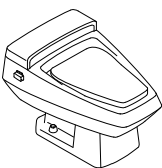
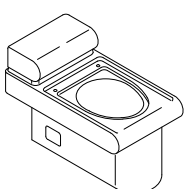
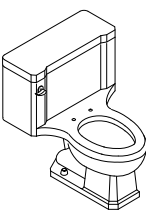

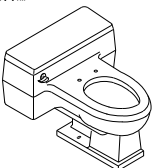







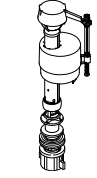
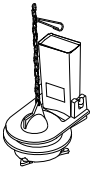
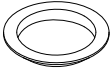
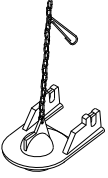

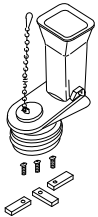
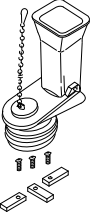
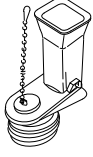
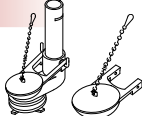
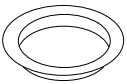
Toilet

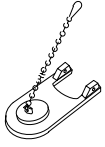
Toilet Details

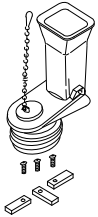
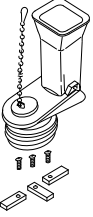
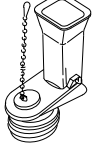
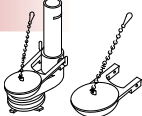
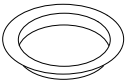
Product Name	Model Number	Tank Cover	Trip Lever
Memoirs [®] 	K-3451 K-3453	1220279* Classic  1220280* Stately 	1039863* 
Palarre [™] 	K-3383	Discontinued	Various trip levers; visit KOHLER.com/ServiceParts .
Pillow Talk [™] 	K-3378	Discontinued	Various trip levers; visit KOHLER.com/ServiceParts .
Placid [™] 	K-3405 K-3600	Discontinued	51170* 
Pompton [™] 	K-3400	Discontinued	51170* 

2-Inch Flapper One-Piece Toilets

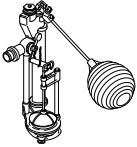
2-Inch Flapper One-Piece Toilets KOHLER® Genuine Parts

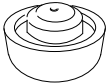
Float/Fill Valve	Flush Valve	Tank Gasket	Flush Ball/Flapper
<p>GP1138930</p> 	<p>87998</p> 	<p>GP83996</p> 	<p>GP1078440</p> 
<p>84499</p>  	<p>83650</p>  <hr style="border-top: 1px dashed black;"/> <p>83094</p>  <p>DISCONTINUED Use 83094</p>  <p>If your toilet currently has this style flush valve and flapper, we recommend they be replaced with flush valve 83094 to prevent potential water damage.</p>	<p>GP53410</p>  <hr style="border-top: 1px dashed black;"/> <p>GP83888</p> 	<p>GP83064</p>  <hr style="border-top: 1px dashed black;"/> <p>GP83064</p> 
<p>84499</p>  	<p>83650</p>  <hr style="border-top: 1px dashed black;"/> <p>83094</p>  <p>DISCONTINUED Use 83094</p>  <p>If your toilet currently has this style flush valve and flapper, we recommend they be replaced with flush valve 83094 to prevent potential water damage.</p>	<p>GP53410</p>  <hr style="border-top: 1px dashed black;"/> <p>GP83888</p> 	<p>GP83064</p>  <hr style="border-top: 1px dashed black;"/> <p>GP83064</p> 
<p>Discontinued</p>	<p>Discontinued</p>	<p>Discontinued</p>	<p>N/A</p>
<p>30668</p> 	<p>30668</p> 	<p>1145626</p> 	<p>GP88921</p> 







**2-Inch Flapper
One-Piece Toilets**

Note: Part numbers that have a "GP" prefix refer to a blister package.
For example, GP1059291 is the same part as previous part number 1059291 but in a blister package.

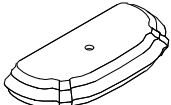
2-Inch Flapper One-Piece Toilets

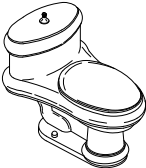
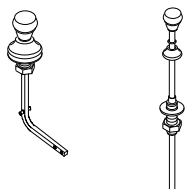
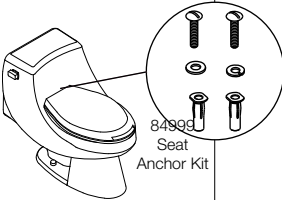

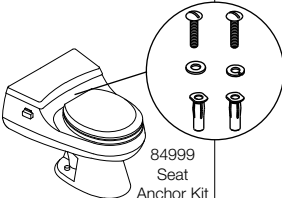
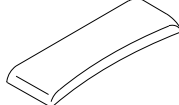

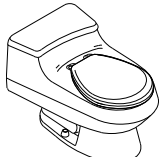





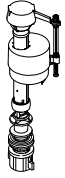
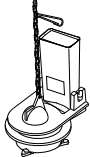

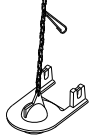
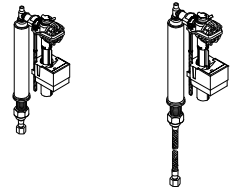





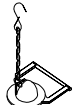
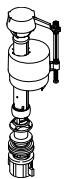

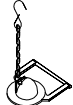

Toilet

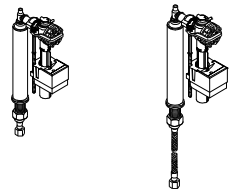
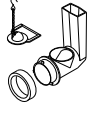
Toilet Details

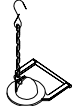
Product Name	Model Number	Tank Cover	Trip Lever
Portrait® 	K-3357 Artist Editions®: K-14261	89809* 	83725* 
Revival® 	K-3360, K-3612 Artist Editions: K-14230	Discontinued	1000833* 83725* 
Rosario™ 	K-3434	Discontinued	78423* 
Rialto® 	K-3386 K-3804	84252* 	85114* 
Rialto 	K-3402	Discontinued	Various trip levers; visit KOHLER.com/ServiceParts .

2-Inch Flapper One-Piece Toilets

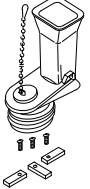
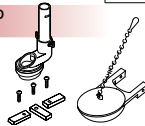
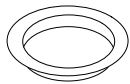
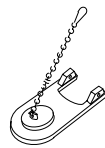
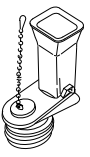
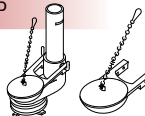
2-Inch Flapper One-Piece Toilets KOHLER® Genuine Parts

Float/Fill Valve	Flush Valve	Tank Gasket	Flush Ball/Flapper
<p>GP1138930</p> 	<p>89827 1060862</p> 	<p>GP83996</p> 	<p>GP89825</p> 
<p>1007490 (Brass Shank) GP1068030 (Plastic Shank)</p> <p>For Rigid Connection For Flex Connection</p> 	<p>84305</p> 	<p>GP83996</p> 	<p>GP1078440</p> 
	<p>1000837</p> 	<p>84676</p> 	<p>GP84995</p> 
<p>GP1138930</p> 	<p>86972</p> 	<p>84676</p> 	<p>GP84995</p> 
	<p>83093</p> 	<p>GP83888</p> 	<p>GP83064</p> 
<p>GP1068030 1068033</p> <p>For Rigid Connection For Flex Connection</p> 	<p>1078578</p> 	<p>84676</p> 	<p>GP84995</p> 
	<p>84302</p> 	<p>GP83996</p> 	<p>GP1078440</p> 
<p>84499</p> 	<p>83650</p>  <p>DISCONTINUED Use 83650</p>  <p>If your toilet currently has this style flush valve and flapper, we recommend they be replaced with flush valve 83650 to prevent potential water damage.</p>	<p>GP53410</p> 	<p>GP83064</p> 
	<p>83095</p>  <p>DISCONTINUED Use 83095</p>  <p>If your toilet currently has this style flush valve and flapper, we recommend they be replaced with flush valve 83095 to prevent potential water damage.</p>	<p>GP83888</p> 	<p>GP83064</p> 



2-Inch Flapper One-Piece Toilets

Note: Part numbers that have a "GP" prefix refer to a blister package. For example, GP1059291 is the same part as previous part number 1059291 but in a blister package.

2-Inch Flapper One-Piece Toilets



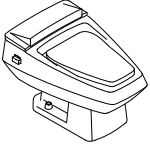
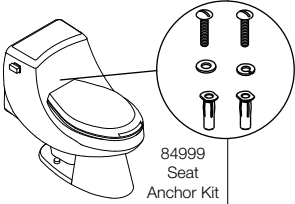









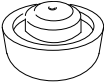
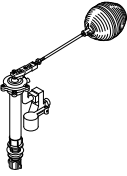
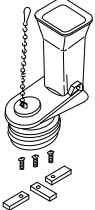
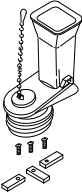
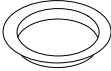

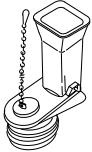
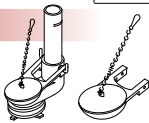

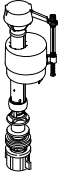
Toilet

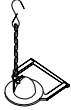
Toilet Details

Product Name	Model Number	Tank Cover	Trip Lever
<p>Rochelle™</p> 	<p>K-3385</p>	<p>Discontinued</p>	<p>Various trip levers; visit KOHLER.com/ServiceParts.</p>
<p>San Martine®</p>  <p>84999 Seat Anchor Kit</p>	<p>K-3435 Artist Editions®: K-14289, K-14290, K-14291</p>	<p>Discontinued</p>	<p>Various trip levers; visit KOHLER.com/ServiceParts.</p>
<p>San Miguel™</p> 	<p>K-3406</p>	<p>Discontinued</p>	<p>Various trip levers; visit KOHLER.com/ServiceParts.</p>

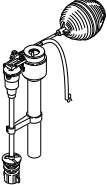
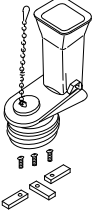
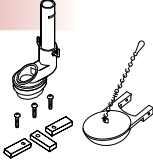
2-Inch Flapper
One-Piece Toilets

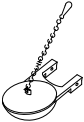
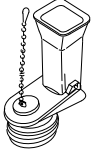
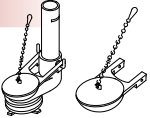
2-Inch Flapper One-Piece Toilets KOHLER® Genuine Parts

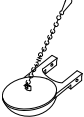
Float/Fill Valve	Flush Valve	Tank Gasket	Flush Ball/Flapper
<p>30668 (prior to 1990)</p> 	<p>30668</p> 	<p>1145626</p> 	<p>GP88921</p> 
<p>84499</p>  	<p>83650</p> 	<p>GP53410</p> 	<p>GP83064</p> 
	<p>83094</p>  <p>DISCONTINUED Use 83094</p>  <p>If your toilet currently has this style flush valve and flapper, we recommend they be replaced with flush valve 83094 to prevent potential water damage.</p>	<p>GP83888</p> 	<p>GP83064</p> 
<p>GP1138930</p> 	<p>86972</p> 	<p>84676</p> 	<p>GP84995</p> 
	<p>83093</p> 	<p>GP83888</p> 	<p>GP83064</p> 
<p>30671</p> 	<p>84216</p>  <p>DISCONTINUED Use 84216</p>  <p>If your toilet currently has this style flush valve and flapper, we recommend they be replaced with flush valve 84216 to prevent potential water damage.</p>	<p>GP53410</p> 	<p>GP49114</p> 
	<p>84217</p>  <p>DISCONTINUED Use 84217</p>  <p>If your toilet currently has this style flush valve and flapper, we recommend they be replaced with flush valve 84217 to prevent potential water damage.</p>	<p>GP83888</p> 	<p>GP49114</p> 







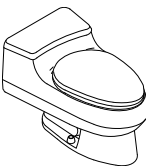
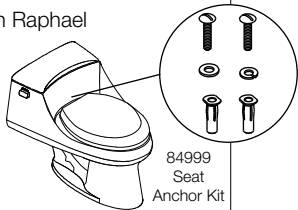

2-Inch Flapper
One-Piece Toilets

Note: Part numbers that have a "GP" prefix refer to a blister package.
For example, GP1059291 is the same part as previous part number 1059291 but in a blister package.

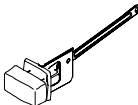
2-Inch Flapper One-Piece Toilets



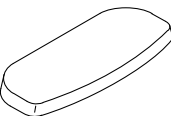







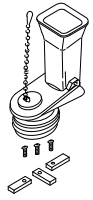

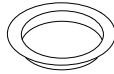

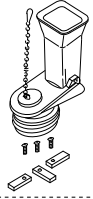

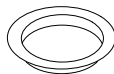

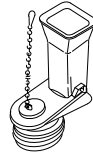
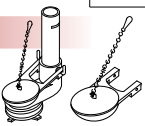

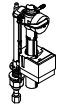
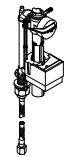
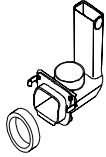

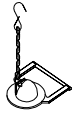
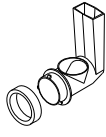
Toilet

Toilet Details

Product Name	Model Number	Tank Cover	Trip Lever
San Raphael® 	K-3395	Discontinued	Various trip levers; visit KOHLER.com/ServiceParts .
San Raphael 	K-3397	Discontinued	Various trip levers; visit KOHLER.com/ServiceParts .
San Raphael  <p style="font-size: small;">84999 Seat Anchor Kit</p>	K-3466 K-3467	1010658* 	1013521* 
San Raphael 	K-3384	Discontinued	85114* 
Santa Rosa™ 	K-3323 K-3803 K-11899	88497* 	87115* 

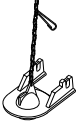
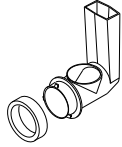
2-Inch Flapper One-Piece Toilets

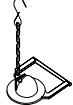
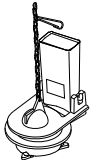
2-Inch Flapper One-Piece Toilets KOHLER® Genuine Parts

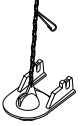
Float/Fill Valve	Flush Valve	Tank Gasket	Flush Ball/Flapper	
Discontinued	<p>83650</p>  <p>DISCONTINUED Use 83650</p> 	<p>GP53410</p>  <p>If your toilet currently has this style flush valve and flapper, we recommend they be replaced with flush valve 83650 to prevent potential water damage.</p>	<p>GP83064</p> 	
84499	<p>83650</p>  <p>DISCONTINUED Use 83650</p> 	<p>GP53410</p>  <p>If your toilet currently has this style flush valve and flapper, we recommend they be replaced with flush valve 83650 to prevent potential water damage.</p>	<p>GP83064</p> 	
	<p>83095</p>  <p>DISCONTINUED Use 83095</p> 	<p>GP83888</p>  <p>If your toilet currently has this style flush valve and flapper, we recommend they be replaced with flush valve 83095 to prevent potential water damage.</p>	<p>GP83064</p> 	
<p>1013282 For Rigid Connection</p> 	<p>1068031 For Flex Connection</p> 	<p>1013944</p>  	<p>84676</p> 	<p>GP84995</p> 
GP1068030	<p>1016123</p>  	<p>84676</p> 	<p>1010376</p> 	
	<p>84284</p>  	<p>GP83996</p> 	<p>GP1078440</p> 	
	<p>84996</p>  	<p>84676</p> 	<p>GP84995</p> 	
GP1138930	<p>87998</p> 	<p>GP83996</p> 	<p>GP1078440</p> 	







2-Inch Flapper One-Piece Toilets

Note: Part numbers that have a "GP" prefix refer to a blister package.
For example, GP1059291 is the same part as previous part number 1059291 but in a blister package.

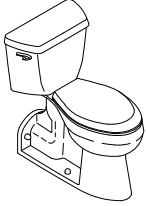
2-Inch Flapper Two-Piece Toilets

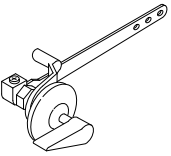
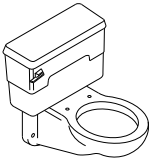
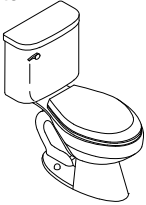
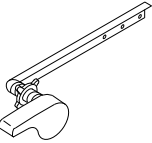









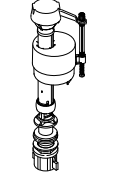
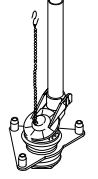

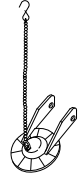
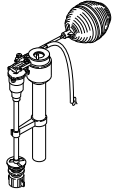
Toilet

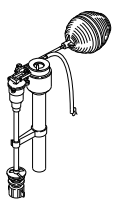
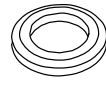
Toilet Details

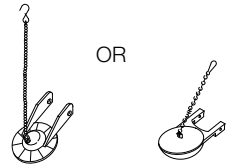
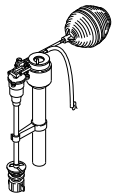
Product Name	Model Number	Tank Cover	Trip Lever
Barrington® Water-Guard® 	K-3530, K-3535, K-3536 Tank: K-4519	Discontinued	Various trip levers; visit KOHLER.com/ServiceParts .
Bolton Aqua Vent 	K-3450 Tank: K-4505 K-3475 Tank: K-4509	Discontinued	500189* 
Cayuga 	K-3440 Tank: K-4509	Discontinued	Various trip levers; visit KOHLER.com/ServiceParts .
Confidante 	K-3556, K-3557 Tank: K-4456	Discontinued	84625* 
Couture 	K-3471, K-3472 Tank: K-4591 Artist Editions®: K-14213 Tank: K-14215 K-14250 Tank: K-14252	Discontinued	Various trip levers; visit KOHLER.com/ServiceParts .
Couture 	K-3477, K-3478, K-3479, K-3480 Tank: K-4605	Discontinued	Various trip levers; visit KOHLER.com/ServiceParts .
Couture Water-Guard 	K-3470 Tank: K-4501 Artist Editions: K-14110 Tank: K-14108 K-14150 Tank: K-14154 K-14128 Tank: K-14129	Discontinued	Various trip levers; visit KOHLER.com/ServiceParts .

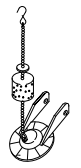
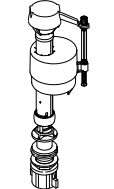
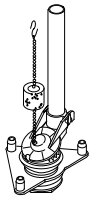
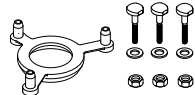
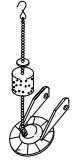
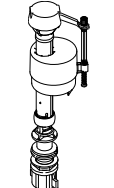
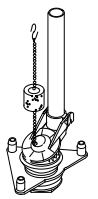
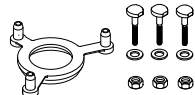
2-Inch Flapper Two-Piece Toilets

2-Inch Flapper Two-Piece Toilets KOHLER® Genuine Parts

Float/Fill Valve	Flush Valve	Tank Gasket	Flush Ball/Flapper
<p>GP1138930</p> 	<p>85406</p> 	<p>GP51487</p> 	<p>GP87449</p> 
<p>30671</p> 	<p>Discontinued</p>	<p>Discontinued</p>	<p>GP87449</p> 
<p>30671</p> 	<p>Discontinued</p>	<p>51531</p>  <p>GP52050</p> 	<p>GP87449 GP49114</p> <p>OR</p> 
<p>30671</p> 	<p>Discontinued</p>	<p>GP51487</p> 	<p>GP85160</p> 
<p>GP1138930</p> 	<p>1003068</p> 	<p>GP51487</p> 	<p>GP85160</p> 
<p>GP1138930</p> 	<p>1007489</p> 	<p>GP51487</p> 	<p>GP85160</p> 
<p>Discontinued</p>	<p>Discontinued</p>	<p>GP51487</p> 	<p>GP87449</p> 







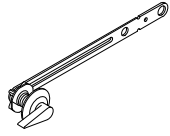

2-Inch Flapper
Two-Piece Toilets

Note: Part numbers that have a "GP" prefix refer to a blister package.
For example, GP1059291 is the same part as previous part number 1059291 but in a blister package.

2-Inch Flapper Two-Piece Toilets

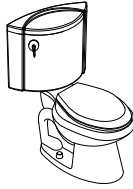



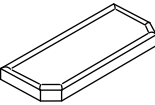



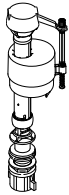
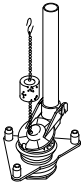

Toilet

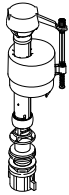
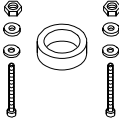
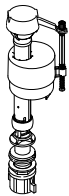
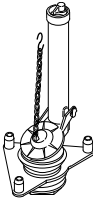
Toilet Details

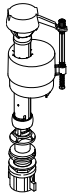
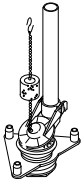
Product Name	Model Number	Tank Cover	Trip Lever
Devonshire® 	K-3457 Tank: K-4619	Discontinued	85086* 
Fleur 	K-3417 Tank: K-4586	Discontinued	Various trip levers; visit KOHLER.com/ServiceParts .
Fleur 	K-3447 Tank: K-4606	Discontinued	83725* 
Folio 	K-3419, K-3445, K-3448, K-3449, K-3454 Tank: K-4447	Discontinued	Various trip levers; visit KOHLER.com/ServiceParts .
Iron Works® 	K-3456, K-3463 Tank: K-4401	89970* 	1010199* 
Kathryn® 	K-3484 Tank: K-4403	1015781* 	Discontinued

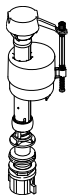
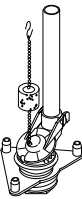
**2-Inch Flapper
Two-Piece Toilets**

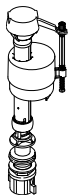
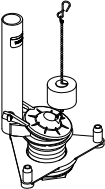
2-Inch Flapper Two-Piece Toilets KOHLER® Genuine Parts

Float/Fill Valve	Flush Valve	Tank Gasket	Flush Ball/Flapper
GP1138930 	84665 	GP51487 	GP85160 
GP1138930 	Discontinued	84539 	N/A
GP1138930 	85302 	GP51487 	GP87449 
GP1138930 	1004808 	GP51487 	GP85160 
GP1138930 	1003068 	GP51487 	GP85160 
GP1138930 	1020751 	GP51487 	GP85160 











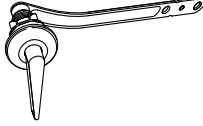

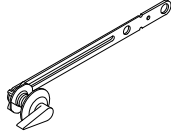
2-Inch Flapper
Two-Piece Toilets

Note: Part numbers that have a "GP" prefix refer to a blister package.
For example, GP1059291 is the same part as previous part number 1059291 but in a blister package.

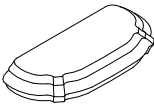
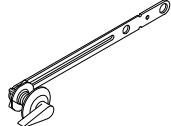
2-Inch Flapper Two-Piece Toilets

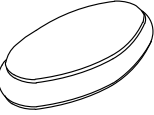



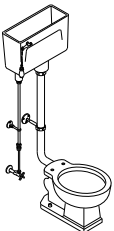





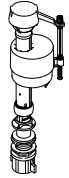
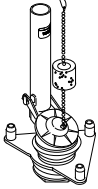

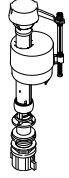
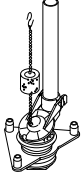
Toilet

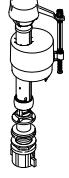
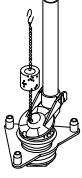
Toilet Details

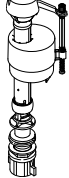
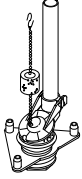
Product Name	Model Number	Tank Cover	Trip Lever
Leighton® 	K-3486, K-3651 Tank: K-4628	Discontinued	1022562* 
Memoirs® 	<p style="text-align: center;">Classic K-3429, K-3452 Tank: K-4454</p> <p style="text-align: center;">Stately K-3439, K-3462 Tank: K-4464</p>	Discontinued	85086* 
Pinoir® 	K-3465, K-3482, K-3483, K-3485 Tank: K-4609	Discontinued	85085* LH 1007913* RH 
Portrait® Lite 	K-3591, K-3490, K-3491 Tank: K-4590, K-4807 Artist Editions®: K-14178 Tank: K-14179 K-14247 Tank: K-14249	80625* 	85086* 
Revival® 	K-3555 Tank: K-3613 K-3455 Tank: K-4445 Artist Editions: K-14239 Tank: K-14241	83834* 	83725* 
Serif® 	K-3444, K-3461, K-3464, K-3468 Tank: K-4608	Discontinued	83725* 
Vintage® 	K-3410 Tank: K-4515 <hr style="border-top: 1px dashed black;"/> K-3411, K-3412 Tank: K-4516	Discontinued	Discontinued

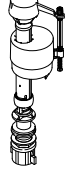
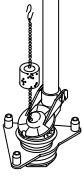
2-Inch Flapper Two-Piece Toilets

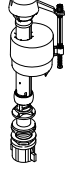
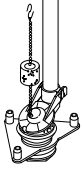
2-Inch Flapper Two-Piece Toilets KOHLER® Genuine Parts

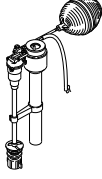
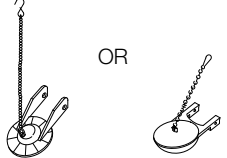
Float/Fill Valve	Flush Valve	Tank Gasket	Flush Ball/Flapper
GP1138930 	1022551 	GP51487 	GP85160 
GP1138930 	1042831 	GP51487 	GP85160 
GP1138930 	1015139 	GP51487 	GP87449 
GP1138930 	87373 (1.6 GPF) 	GP51487 	GP85160 
GP1138930 	85159 	GP51487 	GP85160 
GP1138930 	1004808 	GP51487 	GP85160 
76171 	Discontinued	Discontinued	GP87449 GP49114 ? OR 











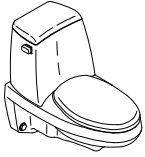
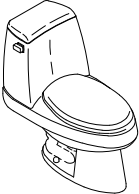

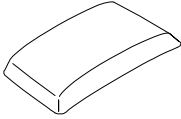
2-Inch Flapper
Two-Piece Toilets

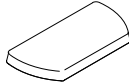
Note: Part numbers that have a "GP" prefix refer to a blister package.
For example, GP1059291 is the same part as previous part number 1059291 but in a blister package.

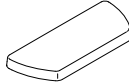
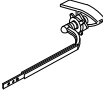
2-Inch Flapper Two-Piece Toilets



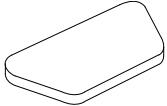







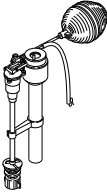

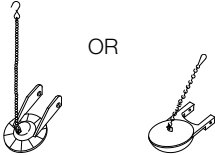
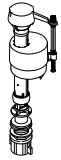

Toilet

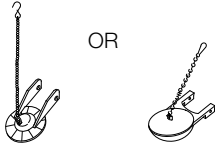
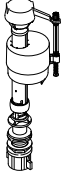
Toilet Details

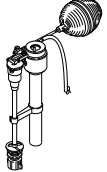
Product Name	Model Number	Tank Cover	Trip Lever
Wellesley Water-Guard® 	K-3441 Tank: K-4209	Discontinued	Various trip levers; visit KOHLER.com/ServiceParts .
Wellington  	K-3446 Tank: K-4646 Artist Editions®: K-14210 Tank: K-14212	83584* 	Various trip levers; visit KOHLER.com/ServiceParts .
	K-3415 Tank: K-4504 Artist Editions: K-14133 Tank: K-14137 K-14143 Tank: K-14147 K-14076 Tank: K-14078	Discontinued	Various trip levers; visit KOHLER.com/ServiceParts .
Wellworth®, Highline® 	K-3433, K-3438 Tank: K-4621	84095* 	30324* 
	K-11450, K-11470, K-3422, K-3423, K-3432, K-3427, K-3481 Tank: K-4620	84591* 	87114* 
Highline Water-Guard 	K-3527 Tank: K-4518	Discontinued	87115* 
Wellworth 	K-3407, K-3420, K-3421, K-3428 Tank: K-4512 K-3414 Tank: K-4597	82869* (7 ³ / ₄ " Discontinued 80625* (10") 	Various trip levers; visit KOHLER.com/ServiceParts .
Wellworth, Northline Water-Guard 	K-3520, K-3521 Tank: K-4519	Discontinued	Various trip levers; visit KOHLER.com/ServiceParts .

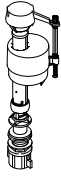
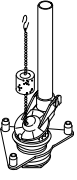
2-Inch Flapper Two-Piece Toilets

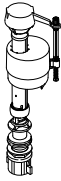
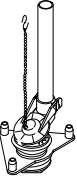
2-Inch Flapper Two-Piece Toilets KOHLER® Genuine Parts

Float/Fill Valve	Flush Valve	Tank Gasket	Flush Ball/Flapper
<p>30652</p> 	<p>Discontinued</p>	<p>GP51487</p> 	<p>GP87449 GP49114</p> <p>OR</p> 
<p>GP1138930</p> 	<p>Discontinued</p>	<p>GP51487</p> 	<p>GP87449</p> 
<p>30652</p> 	<p>Discontinued</p>	<p>GP51487</p> 	<p>GP87449 GP49114</p> <p>OR</p> 
<p>GP1138930</p> 	<p>Discontinued</p>	<p>GP51487</p> 	<p>GP85160</p> 
<p>30671</p> 	<p>Discontinued</p>	<p>GP51487</p> 	<p>GP49114</p> 
<p>GP1138930</p> 	<p>1003068</p> 	<p>GP51487</p> 	<p>GP85160</p> 
<p>GP1138930</p> 	<p>85406</p> 	<p>GP51487</p> 	<p>GP87449</p> 

2-Inch Flapper
Two-Piece Toilets

Note: Part numbers that have a "GP" prefix refer to a blister package.
For example, GP1059291 is the same part as previous part number 1059291 but in a blister package.

2-Inch Flapper Two-Piece Toilets

Toilet



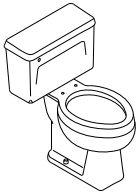
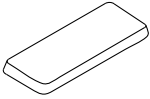
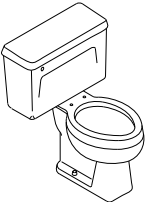
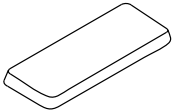



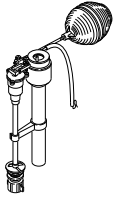

Toilet Details

Product Name	Model Number	Tank Cover	Trip Lever
Wellworth®, Highline®, Tylon, Barlow 	K-3510, K-3512, K-3514 Tank: K-4524	81187* 	Various trip levers; visit KOHLER.com/ServiceParts .
Wellworth Water-Guard® 	K-3500, K-3502, K-3504 Tank: K-4509	81509* 	Various trip levers; visit KOHLER.com/ServiceParts .

NOTES:

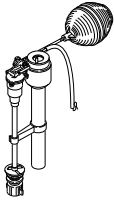
2-Inch Flapper Two-Piece Toilets

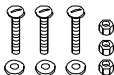
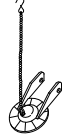
2-Inch Flapper Two-Piece Toilets KOHLER® Genuine Parts

Float/Fill Valve	Flush Valve	Tank Gasket	Flush Ball/Flapper
<p style="text-align: center;">30671</p> 	N/A	<p style="text-align: center;">51531</p>  <p style="text-align: center;">GP52050</p> 	<p style="text-align: center;">GP87449 GP49114</p> <p style="text-align: center;">OR</p>  
<p style="text-align: center;">30672</p> 	N/A	<p style="text-align: center;">51531</p>  <p style="text-align: center;">GP52050</p> 	<p style="text-align: center;">GP87449 GP49114</p> <p style="text-align: center;">OR</p>  







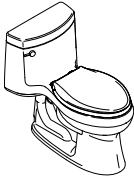
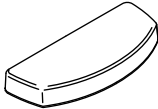
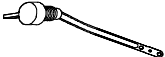

NOTES:

Note: Part numbers that have a “GP” prefix refer to a blister package.
For example, GP1059291 is the same part as previous part number 1059291 but in a blister package.

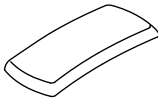
3/4-Inch Flapper One-Piece Toilets

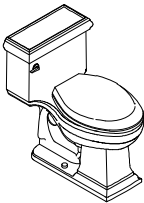
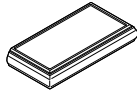
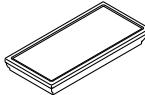
Toilet

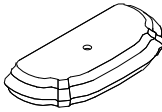





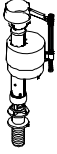
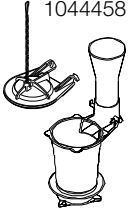

Toilet Details

Product Name	Model Number	Tank Cover	Trip Lever
Cimarron® 	K-3489 K-3802 K-11889	1036367* 	1034693* LH  1036058* RH 
Gabrielle™ 	K-3513, K-3608 Artist Editions®: K-14343, K-14344, K-14345, K-14346	85407* 	1068627* LH  1080378* RH 
Memoirs® 	Classic K-3451 Stately K-3453	1220279* Classic  1220280* Stately 	1039863* 
Portrait® 	K-3506	89809* 	83725* 

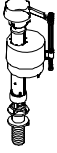
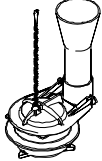
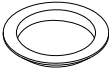
NOTES:

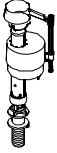
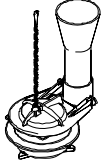
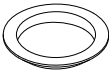
3/4-Inch Flapper
One-Piece Toilets

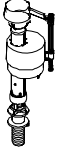
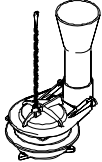
3/4-Inch Flapper One-Piece Toilets
KOHLER® Genuine Parts

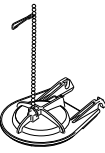
Float/Fill Valve	Flush Valve	Tank Gasket	Flush Ball/Flapper
GP1083167 	1044458 	GP83996 	GP1039444 
GP1083167 	1068622 	GP83996 	GP1067183 
GP1083167 	1039861 	GP83996 	GP1039444 
GP1083167 	1060862 	GP83996 	GP1060740 







NOTES:

Note: Part numbers that have a “GP” prefix refer to a blister package.
 For example, GP1059291 is the same part as previous part number 1059291 but in a blister package.

3/4-Inch Flapper Two-Piece Toilets

Toilet

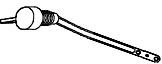

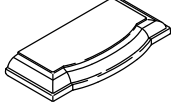
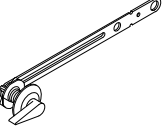
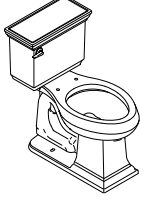
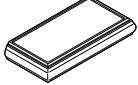
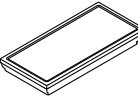
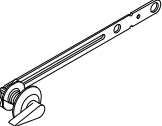



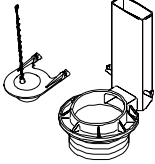

Toilet Details

Product Name	Model Number	Tank Cover	Trip Lever
Bancroft® 	K-3487 Tank: K-4633	1033723* 	1042212* 
Cimarron 	1.28 GPF K-3496-HE Tank: K-4634-HE 1.6 GPF K-3496, K-3497, K-3499, K-11465 Tank: K-4634	1015867* 	1034693* LH  1036058* RH 
Devonshire® 	K-3503 Tank: K-4708	1044820* 	85086* 
Memoirs® 	Classic K-3532, K-3542 Tank: K-4485 K-11461, K-3509, K-3515 Tank: K-4491 Stately K-11460, K-3511, K-3526 Tank: K-4492 K-3533, K-3548 Tank: K-4473	1052861* Classic  1052862* Stately 	85086* 

3/4-Inch Flapper Two-Piece Toilets

NOTES:

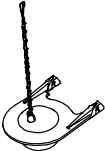
3/4-Inch Flapper Two-Piece Toilets KOHLER® Genuine Parts

Float/Fill Valve	Flush Valve	Tank Gasket	Flush Ball/Flapper
<p>GP1083167</p> 	<p>1042499</p> 	<p>GP1018165-F 1024390</p> 	<p>GP1078441</p> 
<p>GP1083167</p> 	<p>1024385</p> 	<p>GP1018165-F 1024390</p> 	<p>GP1078441</p> 
<p>GP1083167</p> 	<p>1042499</p> 	<p>GP1018165-F 1024390</p> 	<p>GP1078441</p> 
<p>GP1083167</p> 	<p>1060218</p> 	<p>GP1018165-F 1024390</p> 	<p>GP1078441</p> 



3/4-Inch Flapper
Two-Piece Toilets

NOTES:

Note: Part numbers that have a "GP" prefix refer to a blister package.
For example, GP1059291 is the same part as previous part number 1059291 but in a blister package.



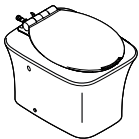
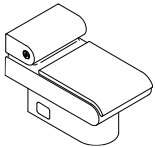
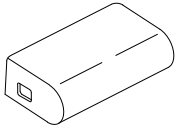
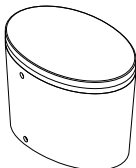
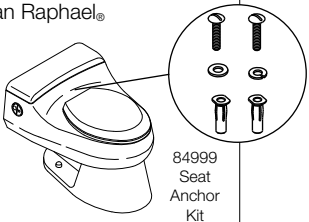
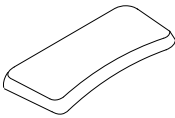

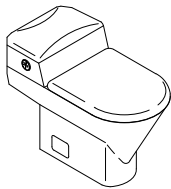
Toilet

Toilet Details

Product Name	Model Number	Tank Cover	Trip Lever
Fountainhead 	K-3524	N/A	N/A
Call Technical Support 800-4KOHLER			
Pillow Talk 	K-3379	83675* 	Various trip levers; visit KOHLER.com/ServiceParts .
Call Technical Support 800-4KOHLER			
Purist® Hatbox 	K-3492	N/A	N/A
Call Technical Support 800-4KOHLER			
San Raphael® 	K-3607 K-3393 K-3398	1055954* 	81996* 
Call Technical Support 800-4KOHLER			
Trocadero 	K-3437	N/A	Various trip levers; visit KOHLER.com/ServiceParts .
Call Technical Support 800-4KOHLER			

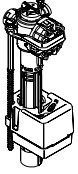
Power Lite®
One-Piece Toilets

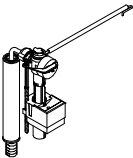
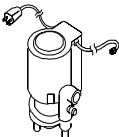
Power Lite® One-Piece Toilets
 KOHLER® Genuine Parts

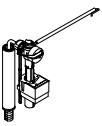
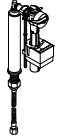
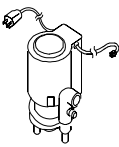
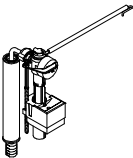
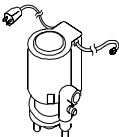
Float/Fill Valve	Flush Valve	Seat
1097551 	1044465 (Pump) 	1057635*
Call Technical Support 800-4KOHLER		
1007489 	84153 (Pump) 	74929*
Call Technical Support 800-4KOHLER		
1043213 	1044465 (Pump) 	1022679*
Call Technical Support 800-4KOHLER		
1007489 For Rigid Connection 	1068034 For Flex Connection 	84153 (Pump) 
Call Technical Support 800-4KOHLER		
1007489 	84153 (Pump) 	K-4612*
Call Technical Support 800-4KOHLER		

Power Lite®
 One-Piece Toilets

Intelligent Toilets

Toilet

Toilet Details

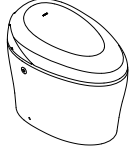
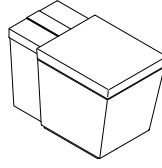
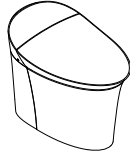
Product Name	Model Number	Tank Cover	Trip Lever
Karing® 	K-4026	N/A	1188925 (Remote Assembly)
	Call Technical Support 800-4KOHLER		
Numi® 	K-3900	N/A	1183987* (User Interface)
	K-3901	N/A	K-7420* (User Interface)
Call Technical Support 800-4KOHLER			
Veil® 	K-5401	N/A	1235953 (Remote Assembly)
	Call Technical Support 800-4KOHLER		

NOTES:











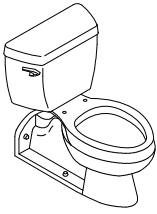
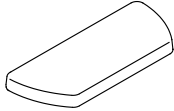

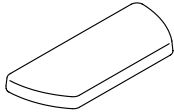

Intelligent Toilets
 KOHLER® Genuine Parts

Float/Fill Valve	Flush Valve	Seat
N/A	N/A	N/A
Call Technical Support 800-4KOHLER		
N/A	N/A	1183995*
N/A	N/A	1214139*
Call Technical Support 800-4KOHLER		
N/A	N/A	K-6299
Call Technical Support 800-4KOHLER		

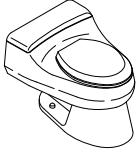
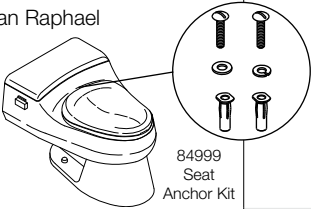
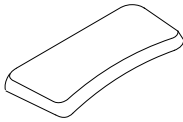
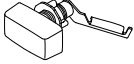

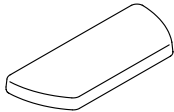



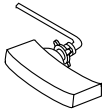

NOTES:

Pressure Lite® One- and Two-Piece Toilets

Toilet Details

Product Name	Model Number	Tank Cover	Trip Lever
Barrington™ 	K-3652 Tank: K-4484	1036375* 	1045276* LH 
			1045277* RH 
Call Technical Support 800-4KOHLER			
Highline® 	K-3493, K-3554 Tank: K-4645 K-3519, K-3531 Tank: K-4484	1036375* 	1045276* LH 
			1045277* RH 
Call Technical Support 800-4KOHLER			
Rialto® 	K-3404	Discontinued	Discontinued
Call Technical Support 800-4KOHLER			
San Raphael® 	K-3394	Discontinued	Discontinued
Call Technical Support 800-4KOHLER			
San Raphael  <p>84999 Seat Anchor Kit</p>	K-3393 K-3597 K-3607	1055954* 	1089001* 
			Call Technical Support 800-4KOHLER
Wellworth® 	K-3505 Tank: K-4645	1036375* 	1045276* LH 
			1045277* RH 
Call Technical Support 800-4KOHLER			
Wellworth, Highline, Barrington 	K-3458, K-3544, K-3546 Tank: K-4470	Discontinued	84874* 
			Call Technical Support 800-4KOHLER

Pressure Lite® One- and Two-Piece Toilets
KOHLER® Genuine Parts

Float/Fill Valve	Flush Valve	Seat	Flush Ball/Flapper
N/A	N/A	84460  GP52050 	N/A
Call Technical Support 800-4KOHLER			
N/A	N/A	GP51487 	N/A
Call Technical Support 800-4KOHLER			
N/A	N/A	N/A	N/A
Call Technical Support 800-4KOHLER			
N/A	N/A	N/A	N/A
Call Technical Support 800-4KOHLER			
N/A	N/A	1104621 	N/A
Call Technical Support 800-4KOHLER			
N/A	N/A	84460  GP52050 	N/A
Call Technical Support 800-4KOHLER			
N/A	N/A	1037307  GP52050 	N/A
Call Technical Support 800-4KOHLER			













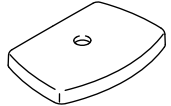
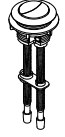

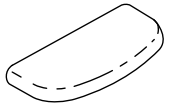
Pressure Lite®
 One- and Two-Piece Toilets

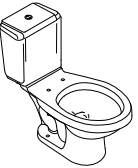
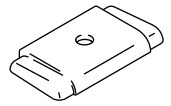
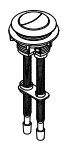
Note: Part numbers that have a “GP” prefix refer to a blister package.
 For example, GP1059291 is the same part as previous part number 1059291 but in a blister package.

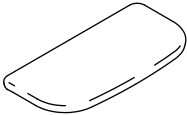
Toilet

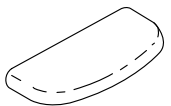









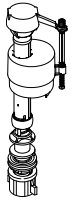

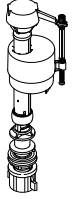
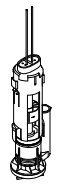



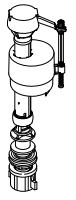
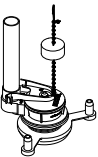

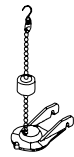
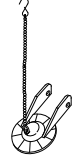
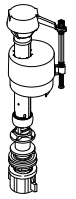
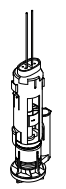

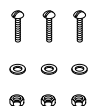
Toilet Details

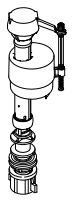
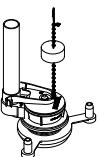
STERLING Toilets

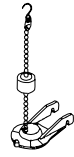
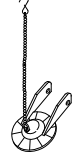
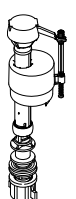
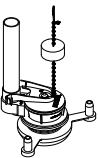
Product Name	Model Number	Tank Cover	Trip Lever																				
Cordova 	402020 402220 Tank: 404520	Discontinued	Discontinued																				
Karsten® 	402025 402087 402028 Tank: 402023	1040340* 	1266856* 																				
Riverton™ 	<table border="0"> <tr> <td>1.28 GPF</td> <td>1.6 GPF</td> </tr> <tr> <td>402083</td> <td>402502</td> </tr> <tr> <td>402084</td> <td>402522</td> </tr> <tr> <td>402085</td> <td>402532</td> </tr> <tr> <td>404701</td> <td></td> </tr> <tr> <td>Tank: 404552</td> <td>Tank: 404522</td> </tr> </table>	1.28 GPF	1.6 GPF	402083	402502	402084	402522	402085	402532	404701		Tank: 404552	Tank: 404522	1169890* (1.28 GPF) 84624* (1.6 GPF) 	84625-CP (Chrome) 1166878-0 (White) 85086-VF (Brass) 								
1.28 GPF	1.6 GPF																						
402083	402502																						
402084	402522																						
402085	402532																						
404701																							
Tank: 404552	Tank: 404522																						
Rockton® 	402024 402027 402088 Tank: 402022	1045794* 	1266856* 																				
Stinson® 	<table border="0"> <tr> <td>1.28 GPF</td> <td>1.6 GPF</td> </tr> <tr> <td>402076</td> <td>402075</td> </tr> <tr> <td>402077</td> <td>402375</td> </tr> <tr> <td>404702</td> <td>Tank: 402071</td> </tr> <tr> <td>404704</td> <td></td> </tr> <tr> <td>Tank: 402091</td> <td></td> </tr> </table>	1.28 GPF	1.6 GPF	402076	402075	402077	402375	404702	Tank: 402071	404704		Tank: 402091		1068490* 	1185068* 								
1.28 GPF	1.6 GPF																						
402076	402075																						
402077	402375																						
404702	Tank: 402071																						
404704																							
Tank: 402091																							
Windham™ 	<table border="0"> <tr> <td>1.28 GPF</td> <td>1.6 GPF</td> </tr> <tr> <td>402080</td> <td>402015</td> </tr> <tr> <td>402081</td> <td>402215</td> </tr> <tr> <td>402082</td> <td>402315</td> </tr> <tr> <td>404700</td> <td>Tank: 404515</td> </tr> <tr> <td>Tank: 404555</td> <td></td> </tr> <tr> <td>402078</td> <td>402014</td> </tr> <tr> <td>402079</td> <td>402214</td> </tr> <tr> <td>Tank: 404544</td> <td>402315</td> </tr> <tr> <td></td> <td>Tank: 404514</td> </tr> </table>	1.28 GPF	1.6 GPF	402080	402015	402081	402215	402082	402315	404700	Tank: 404515	Tank: 404555		402078	402014	402079	402214	Tank: 404544	402315		Tank: 404514	84537* 	84625-CP (Chrome) 1166878-0 (White) 85086-VF (Brass) 
1.28 GPF	1.6 GPF																						
402080	402015																						
402081	402215																						
402082	402315																						
404700	Tank: 404515																						
Tank: 404555																							
402078	402014																						
402079	402214																						
Tank: 404544	402315																						
	Tank: 404514																						
Windham 	<table border="0"> <tr> <td>1.28 GPF</td> <td>1.6 GPF</td> </tr> <tr> <td>403080</td> <td>402211</td> </tr> <tr> <td>403081</td> <td>402212</td> </tr> <tr> <td>403082</td> <td>402213</td> </tr> <tr> <td>404705</td> <td>Tank: 402093</td> </tr> <tr> <td>Tank: 404551</td> <td></td> </tr> </table>	1.28 GPF	1.6 GPF	403080	402211	403081	402212	403082	402213	404705	Tank: 402093	Tank: 404551		1203861* 	84625-CP (Chrome) 1166878-0 (White) 85086-VF (Brass) 								
1.28 GPF	1.6 GPF																						
403080	402211																						
403081	402212																						
403082	402213																						
404705	Tank: 402093																						
Tank: 404551																							

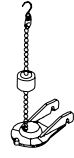
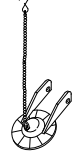
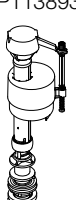
STERLING® Toilets
KOHLER® Genuine Parts

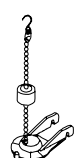
STERLING Toilets

Float/Fill Valve	Flush Valve	Tank Gasket	Flush Ball/Flapper
GP1138930 	N/A	GP51487 	GP87449 1.6 GPF 
GP1138930 	1072320 	1032265  30419 	1131496 
GP1138930 	1110262 (1.28 GPF) 84910 (1.6 GPF) 	GP51487 	GP1105825 1.28 GPF  OR GP87449 1.6 GPF 
GP1138930 	1072320 	1032265  30419 	1131496 
GP1138930 	1110262 (1.28 GPF) 84910 (1.6 GPF) 	GP51487 	GP1105825 1.28 GPF  OR GP87449 1.6 GPF 
GP1138930 	1110262 (1.28 GPF) 85073 (1.6 GPF) 	GP51487 	GP1105825 1.28 GPF  OR GP87449 1.6 GPF 
GP1138930 	1212845 (1.28 GPF) 1284420 (1.6 GPF) 	GP51487 	GP1105825 1.28 GPF  OR GP87449 1.6 GPF 

Note: Part numbers that have a "GP" prefix refer to a blister package.
For example, GP1059291 is the same part as previous part number 1059291 but in a blister package.